

The perfect elements to a blissful life.



Your bliss, found.

In your hands right now,
within these few leaves of paper,
we disclose to you the
hidden secrets of the northeast.
Here is where the perfect elements to
a blissful life have been enjoyed quietly,
for ages. And soon,
it will be yours.

Bestowed with the knowledge
of how certain elements in nature can
heighten every experience,
we have created a habitat
of refuge – where you can be one
with the environment, where poetic
eco-living is at its finest.

Your home in Bliss@Kovan
binds together these essential elements,
harnessing their energies – to
create a harmonious balance,
for a life embraced
in fullness and purpose.

That joyous place which you
have been seeking your entire life,
has finally been found.
Welcome.



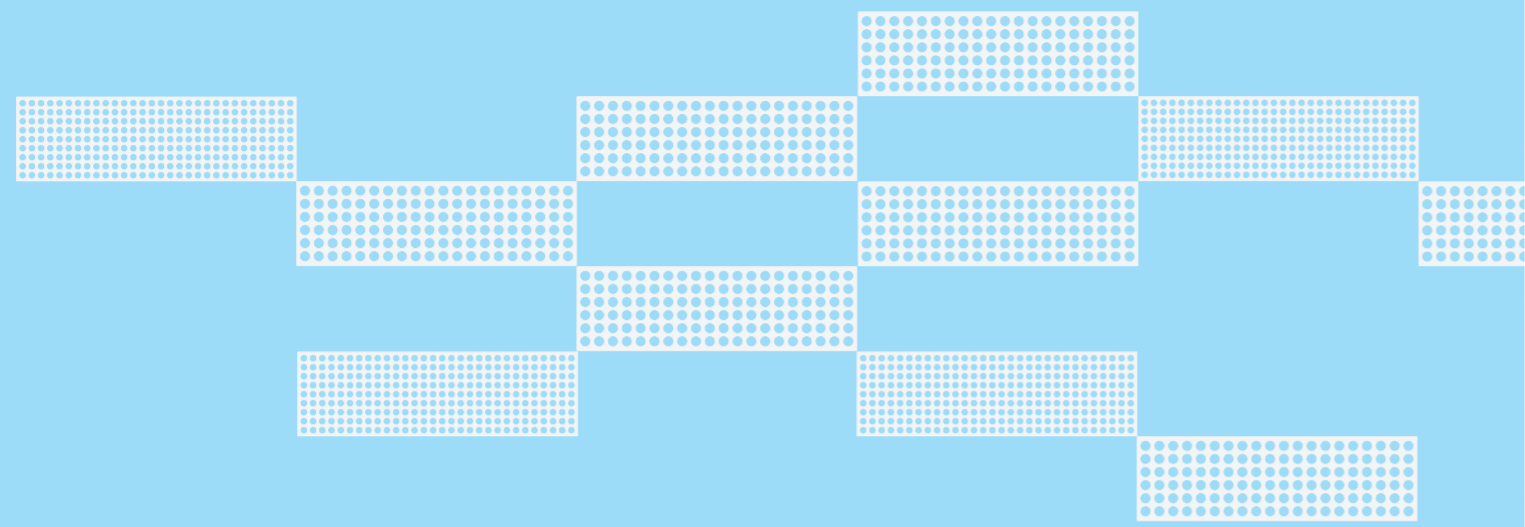

Taming The Wind Above.

Be greeted by a gentle, soothing breeze. From the moment you set foot into Bliss@Kovan, right to your doorstep. Sweeping the fleeting winds down from the skies above, uniquely designed trellises sprawling over the roof terrace provide a steady stream of air through the residence – breathing new life, new beginnings. And like a tree's canopy, it also shades away the sun – transforming the idyllic green landscape into a cool, microclimate environment that is yours to take in, with every breath, every single day.

Ever so inviting, ever so uplifting, this is where home is. And you have arrived.

◀ **Wind** embodies a nature of renewal and invigoration, an arrival of hope and a breath of soothing energy.

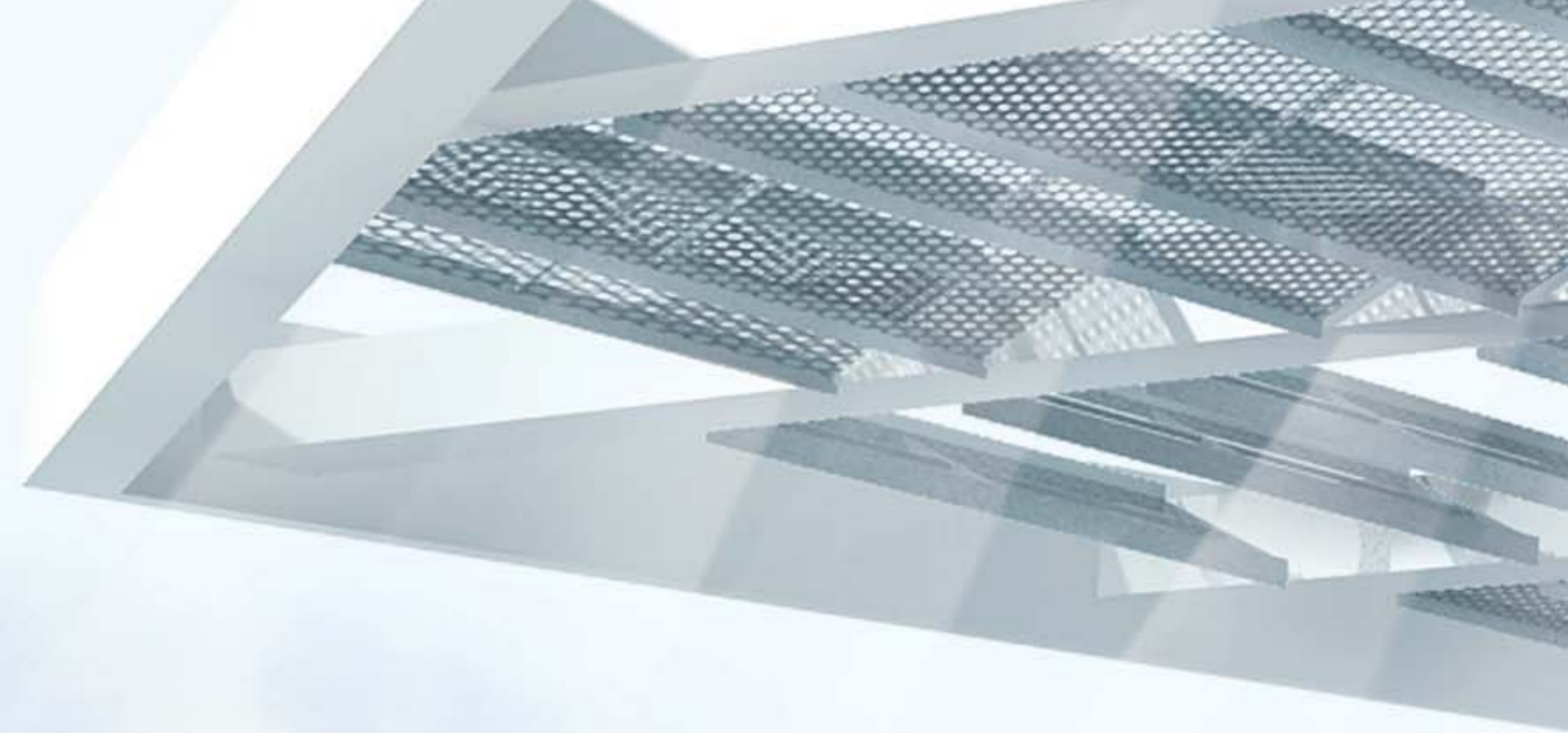

A canopy inspired by nature,
designed specially for you.





Artist's Impression



Artist's Impression



Artist's Impression

Think of home as more than a freehold residence of 140 exclusive units quietly tucked away in a mature private estate in north-east Singapore. Think of it as a biotope of possibilities – a place where nature inspires the way you live and nurtures your very well being.

Here you are one, with all that surrounds you.

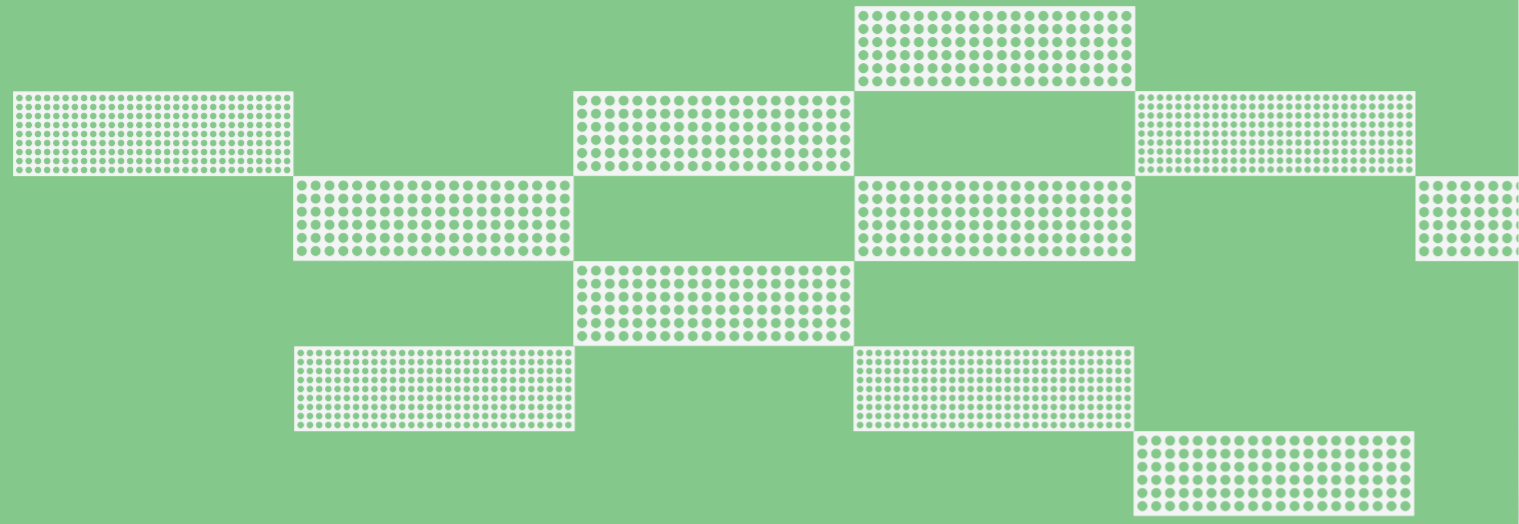

Chiselled to Complement Nature.

Everything you find at Bliss@Kovan has a purpose. From the well-positioned north-south facing housing block, and the finely crafted landscape adorned with plush trees and gardens, to the vertical green wall and rainwater harvesting features. Every single architectural detail is carefully thought out and integrated to create a conducive, sustainable environment – where both you and nature can grow and flourish in perfect harmony, in one dynamic ecosystem.

Spend your days in the embrace of nature; swoon over its arresting beauty and tranquility and uncover a more profound experience and love, for life.

◀ **Earth** symbolises a resoluteness of matter, a wilful magnificence to thrive, and a dominance to fulfill its sole purpose: to create.



Where form meets function and ingenuity, naturally.



Imagine a home built with you and the environment in mind. A place with green innovative features that improve energy and water efficiencies, protect and care for the eco-system, and preserves all that you hold dear. Such a place has been conferred the internationally renowned BCA Green Mark Gold Plus Award. And this place is Bliss@Kovan.



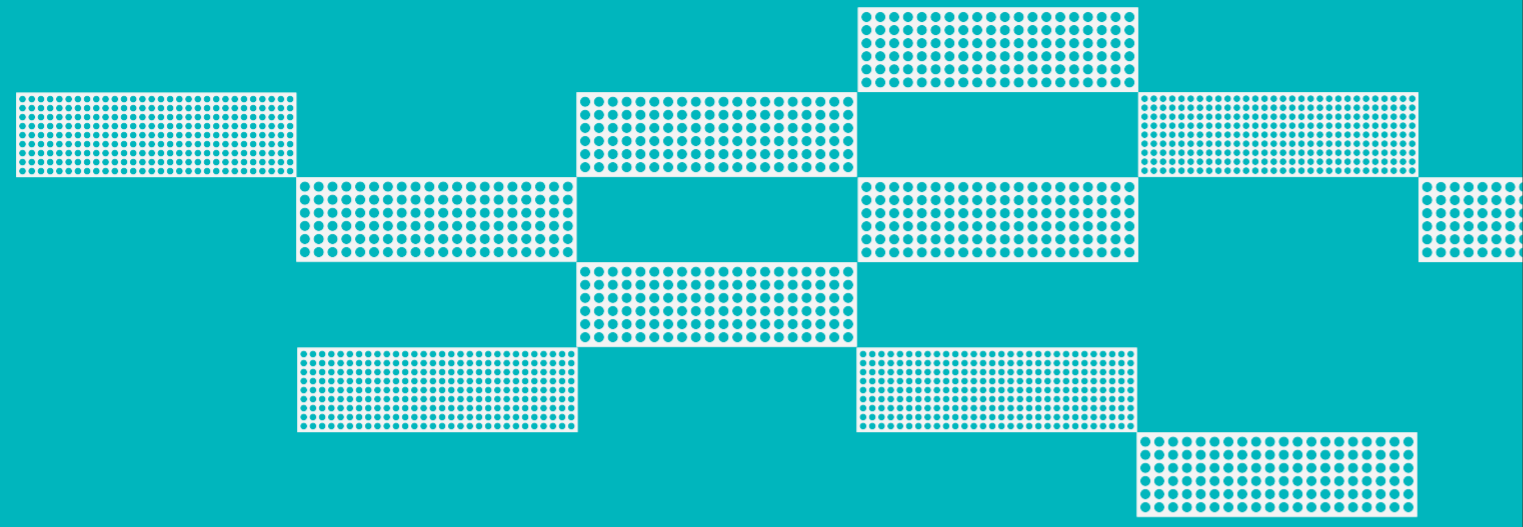

A Wellspring of Life's Simple Joys.

Your journey into the plentiful life begins with an ever-flowing choice of indulgences. An oasis for the mind, body and soul to recharge, replenish and renew its energies, here you will find a range of top-class facilities and recreational areas, all meticulously put together for your picking. Be it a quiet spot to collect your thoughts, a gathering place for a cherished few, or a pit stop to invigorate your senses, there's always an abundance of life's simple luxuries to relish.

Your sanctuary of wellness awaits. Go on, soak it all in.

Water conveys the purest essence of connectedness, a restoration of passions, and the source of power and rejuvenation.

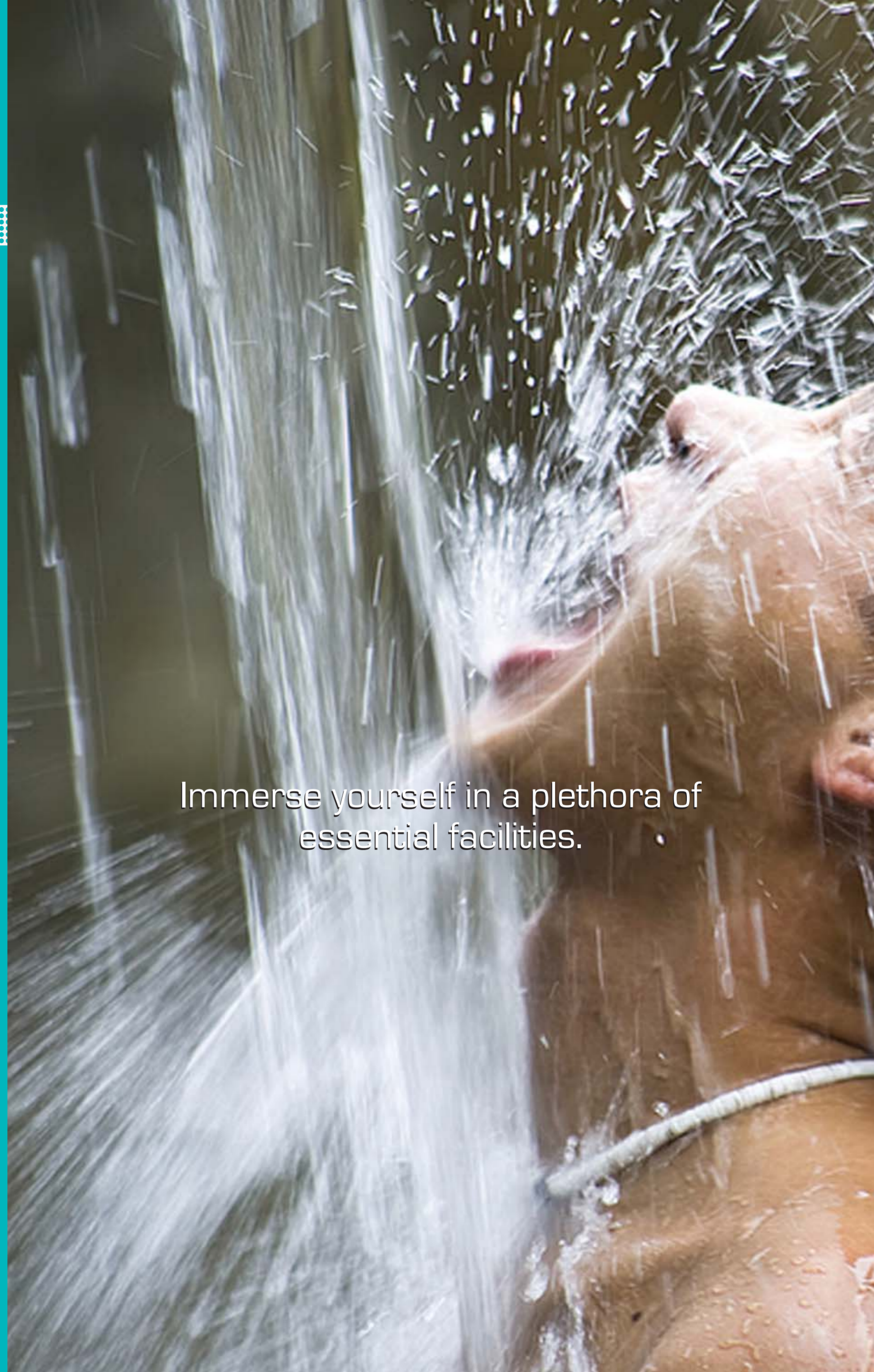

Immerse yourself in a plethora of essential facilities.



Escape into your world. It's all yours to enjoy at Bliss@Kovan. Take a refreshing swim, a relaxing massage or just bask under the shade amid serene greenery. Pump up your adrenaline in the state-of-the-art gym, or spend quality time with friends and family at the outdoor dining pavilion while watching the kids play at the playground.

This is how life should be – having it your way, every day.



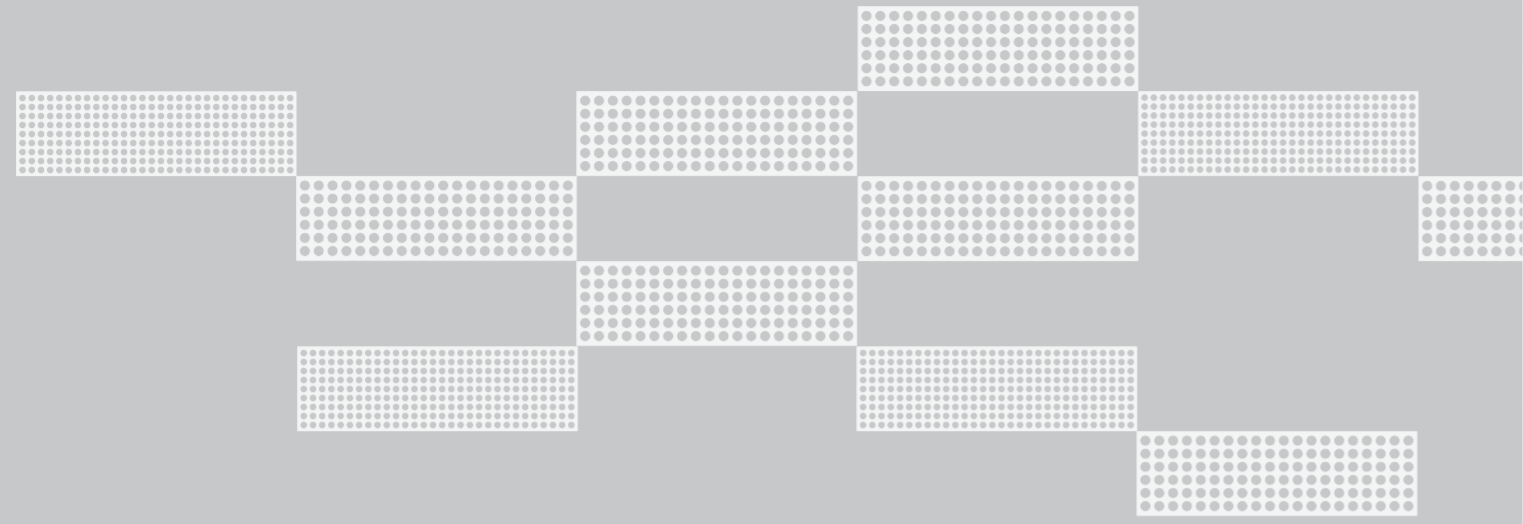

The Spaces Between.

Welcome. To a whole new dimension of living. Where the essence of space is defined by seamless fluidity, well-appointed interiors and abundant natural lighting.

But a place where every detail, from the high ceilings – up to 4m for penthouse units, down to natural marble and timber floorings; from the ingeniously designed kitchen, living, dining areas to the cosy bedrooms and balcony – is created to redefine the way you and your family members experience and interact with personal living spaces. Bringing about a heightened sense of belonging, warmth and closeness.

This is how home should feel like.



Where you'll always find room
to grow, inspire and live.



Artist's Impression

Whatever your preferred lifestyle, there is always ample space to live out your aspirations. Choose from a 1-, 2-, or 3- bedroom units, or open up to the high life with our 22 exclusive penthouses with private rooftop terraces. Unwind and relax amongst the exquisitely manicured planters, tiered timber deck platforms, and take a dip in your very own Jacuzzi or plunge pool as you take in the breathtaking views around. Your personal retreat away from it all, is now just within your reach.



Artist's Impression



Artist's Impression



Artist's Impression



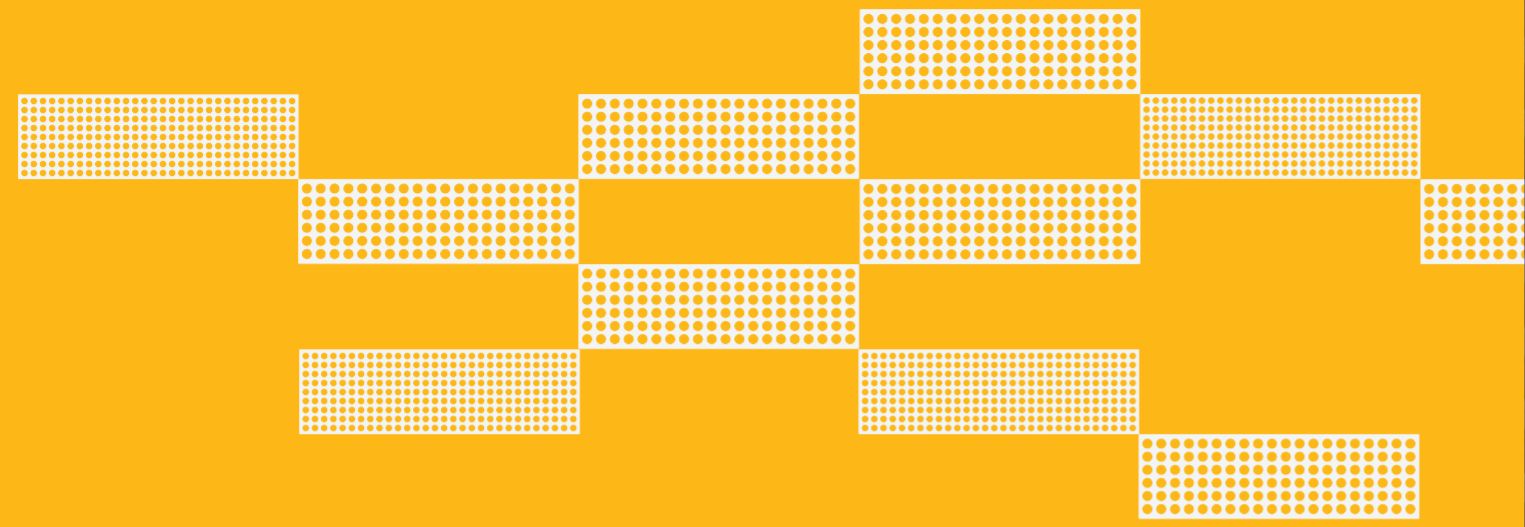

Radiating Many Paths.

Of the many journeys life takes you on, there is only one destination that truly matters. Whatever you do, wherever your pursuits take you, Bliss@Kovan is the place that brings you closer to all that you could want. Located at the crossroads of countless conveniences, it is a beacon of light paving the way for your heart's every desire. Be it work, live or play, seek your passions and you will find. So take pleasure in living the lifestyle you deserve. Choose abundantly. Have no reservations.

◀ **Light** defines the existence of space, it illuminates, inspires and fires the will to pursue and experience life to the fullest.



Ignite your every desire with all you need within easy reach.



With Kovan MRT a mere 5 minutes walk away and major expressways easily accessible from home, commuting to your desired destination, anywhere on the island is simply hassle-free. Well situated near renowned educational institutions like Serangoon Junior College, Paya Lebar Methodist Girls Primary and Secondary Schools, Bliss@Kovan is also a bridge to various lifestyle activities. Enjoy a dose of retail therapy, savour delectable cuisines, or head to the stadium for some cardio workout. There's so much more to look out for at Bliss@Kovan.



Serangoon (NE12) (CC13)



DPS International Sch

Paya Lebar Methodist Girls' Pr Sch

Paya Lebar Methodist Girls' Sec Sch

Site Plan

LEGEND

- 1 Lap Pool
- 2 Children's Play Pool
- 3 Hydro Massage
- 4 Spa Pool and Pavilion
- 5 Outdoor Shower
- 6 Pool Deck
- 7 Communal Male and Female Changing Rooms with Shower Facilities (1st Storey)
- 8 Cascading Water Entrance Court
- 9 Drop-off
- 10 Guardhouse
- 11 Entrance Foyer
- 12 Water Feature
- 13 Secondary Pedestrian Access
- 14 Biological Pond
- 15 Vertical Green Wall and Garden Walk
- 16 Rain Garden with integrated Bioswale
- 17 Signature Tree
- 18 Clubhouse (2nd storey)
- 19 Gym (3rd storey)
- 20 Dining Pavilion with Barbeque and Kitchen Facilities
- 21 Children's Playground



Unit Distribution Chart

Storey	Unit	01	02	03	04	05
	Roof Terrace		Type A8 2,174 sqft	Type A9 2,357 sqft	Type B14 1,765 sqft	
5th		Type A5 1,163 sqft	Type A6 1,249 sqft	Type B9 915 sqft	Type C5 495 sqft	Type B6 797 sqft
4th		Type A5 1,163 sqft	Type A6 1,249 sqft	Type B9 915 sqft	Type C5 495 sqft	Type B6 797 sqft
3rd		Type A5 1,163 sqft	Type A6 1,249 sqft	Type B9 915 sqft	Type C5 495 sqft	Type B6 797 sqft
2nd		Type A5 1,163 sqft	Type A6 1,249 sqft	Type B9 915 sqft	Type C5 495 sqft	Type B6 797 sqft
1st		Type A2 1,313 sqft	Type A3 1,227 sqft	Type B4 936 sqft	Type C1 506 sqft	Type B1 893 sqft

Storey	Unit	06	07	08	09	10
	Roof Terrace		Type A8 2,174 sqft	Type A9 2,357 sqft	Type A7 2,217 sqft	Type C6 592 sqft
5th		Type A5 1,163 sqft	Type A6 1,249 sqft	Type A4 1,227 sqft	Type C6 592 sqft	Type B7 840 sqft
4th		Type A5 1,163 sqft	Type A6 1,249 sqft	Type A4 1,227 sqft	Type C6 592 sqft	Type B7 840 sqft
3rd		Type A5 1,163 sqft	Type A6 1,249 sqft	Type A4 1,227 sqft	Type C6 592 sqft	Type B7 840 sqft
2nd		Type A5 1,163 sqft	Type A6 1,249 sqft	Type A4 1,227 sqft	Type C6 592 sqft	Type B7 840 sqft
1st		Type A2 1,313 sqft	Type A3 1,227 sqft	Type A1 1,130 sqft	Type C2 614 sqft	Type B2 915 sqft

Storey	Unit	11	12	13	14	15
	Roof Terrace		Type B14A 1,765 sqft	Type A9 2,357 sqft	Type A7 2,217 sqft	Type C6 592 sqft
5th		Type B9A 915 sqft	Type A6 1,249 sqft	Type A4 1,227 sqft	Type C6 592 sqft	Type B7 840 sqft
4th		Type B9A 915 sqft	Type A6 1,249 sqft	Type A4 1,227 sqft	Type C6 592 sqft	Type B7 840 sqft
3rd		Type B9A 915 sqft	Type A6 1,249 sqft	Type A4 1,227 sqft	Type C6 592 sqft	Type B7 840 sqft
2nd		Type B9A 915 sqft	Type A6 1,249 sqft	Type A4 1,227 sqft	Type C6 592 sqft	Type B7 840 sqft
1st		Type B4 936 sqft	Type A3 1,227 sqft	Type A1 1,130 sqft	Type C2 614 sqft	Type B2 915 sqft

Storey	Unit	16	17	18	19
	Roof Terrace		Type B15 1,776 sqft	Type A8 2,174 sqft	Type A9 2,357 sqft
5th		Type B10 926 sqft	Type A5 1,163 sqft	Type A6 1,249 sqft	Type C7 527 sqft
4th		Type B10 926 sqft	Type A5 1,163 sqft	Type A6 1,249 sqft	Type C7 527 sqft
3rd		Type B10 926 sqft	Type A5 1,163 sqft	Type A6 1,249 sqft	Type C7 527 sqft
2nd		Type B10 926 sqft	Type A5 1,163 sqft	Type A6 1,249 sqft	Type C7 527 sqft
1st		Type B5 936 sqft	Type A2 1,313 sqft	Type A3 1,227 sqft	Type C3 560 sqft

Storey	Unit	20	21	22	23	24
	Roof Terrace		Type B12 1,679 sqft	Type A8 2,174 sqft	Type A9 2,357 sqft	Type A8 2,174 sqft
5th		Type B7 840 sqft	Type A5 1,163 sqft	Type A6 1,249 sqft	Type A5 1,163 sqft	Type C6 592 sqft
4th		Type B7 840 sqft	Type A5 1,163 sqft	Type A6 1,249 sqft	Type A5 1,163 sqft	Type C6 592 sqft
3rd		Type B7 840 sqft	Type A5 1,163 sqft	Type A6 1,249 sqft	Type A5 1,163 sqft	Type C6 592 sqft
2nd		Type B7 840 sqft	Type A5 1,163 sqft	Type A6 1,249 sqft	Type A5 1,163 sqft	Type C6 592 sqft
1st		Type B2 915 sqft	Type A2 1,313 sqft	Type A3 1,227 sqft	Type A2 1,313 sqft	Type C2 614 sqft

Storey	Unit	25	26	27	28
	Roof Terrace		Type B13 1,808 sqft	Type C8 527 sqft	Type A9 2,357 sqft
5th		Type B8 904 sqft	Type C8 527 sqft	Type A6 1,249 sqft	Type A5 1,163 sqft
4th		Type B8 904 sqft	Type C8 527 sqft	Type A6 1,249 sqft	Type A5 1,163 sqft
3rd		Type B8 904 sqft	Type C8 527 sqft	Type A6 1,249 sqft	Type A5 1,163 sqft
2nd		Type B8 904 sqft	Type C8 527 sqft	Type A6 1,249 sqft	Type A5 1,163 sqft
1st		Type B3 1,023 sqft	Type C4 527 sqft	Type A3 1,227 sqft	Type A2 1,313 sqft

- Penthouse
- Type C
- 1 Bedroom
- Type B
- 2 Bedroom
- Type A
- 3 Bedroom

Type C1

47 sq m/506 sq ft
(Including PES 8 sq m/86 sq ft)

1 Bedroom -1G (Ground Level)
#01-04

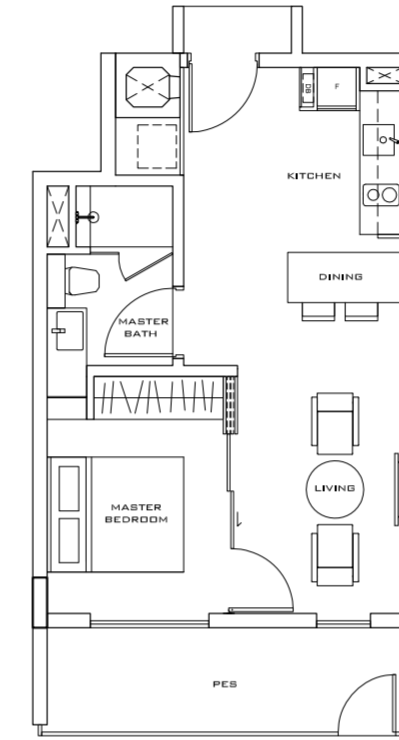

Type C5

46 sq m/495 sq ft

1 Bedroom -1
#02-04, 03-04, 04-04, 05-04

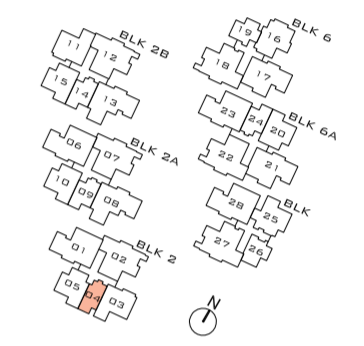
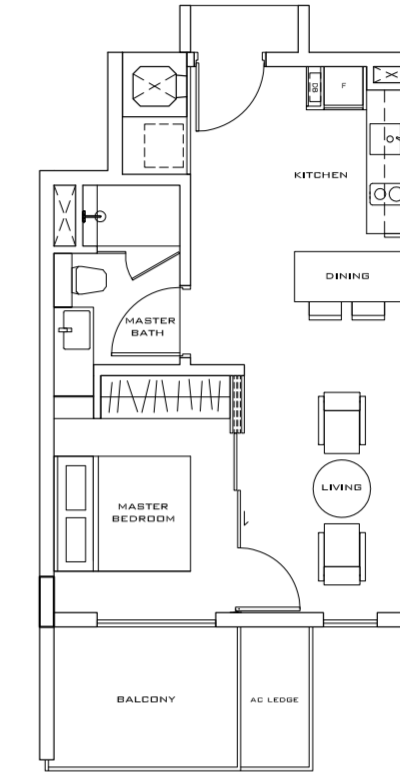

Type C2

57 sq m/614 sq ft
(Including PES 10 sq m/108 sq ft)

1 Bedroom -2G (Ground Level)
#01-09, 01-14, 01-24

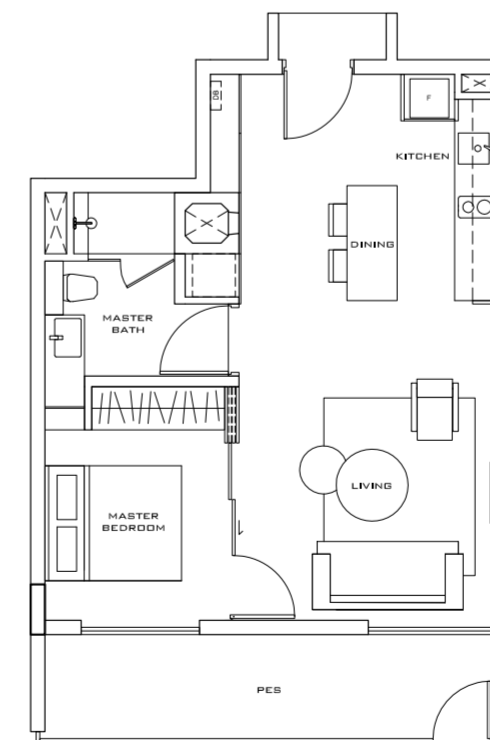

Type C6

55 sq m/592 sq ft

1 Bedroom -2
#02-09, 03-09, 04-09, 05-09
#02-14, 03-14, 04-14, 05-14
#02-24, 03-24, 04-24, 05-24

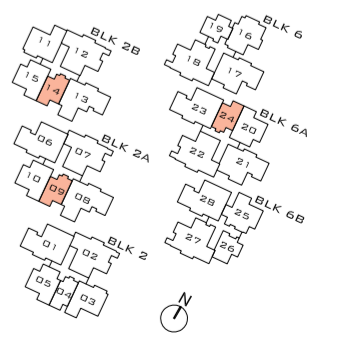
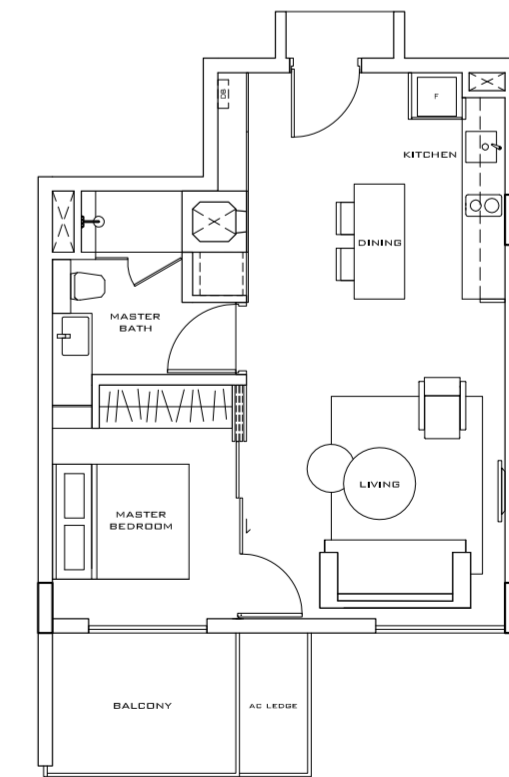

Area includes PES, balcony, AC ledge, planter, private pool and roof terrace. Plans are not drawn to scale and are subject to such amendment(s) as may be required or approved by the relevant authorities. All areas are approximate and are subject to final survey. The brand and model of all fittings, equipment and appliances supplied are subject to availability. In the event that they are not available, the developer will offer replacements of equivalent standard or value.

Type C3

52 sq m/560 sq ft
(Including PES 12 sq m/129 sq ft)

1 Bedroom -3G (Ground Level)
#01-19

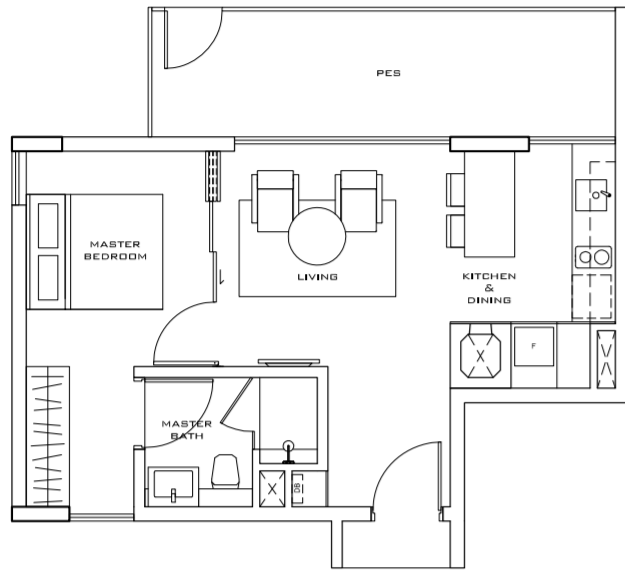

Type C7

49 sq m/527 sq ft

1 Bedroom -3
#02-19, 03-19, 04-19, 05-19

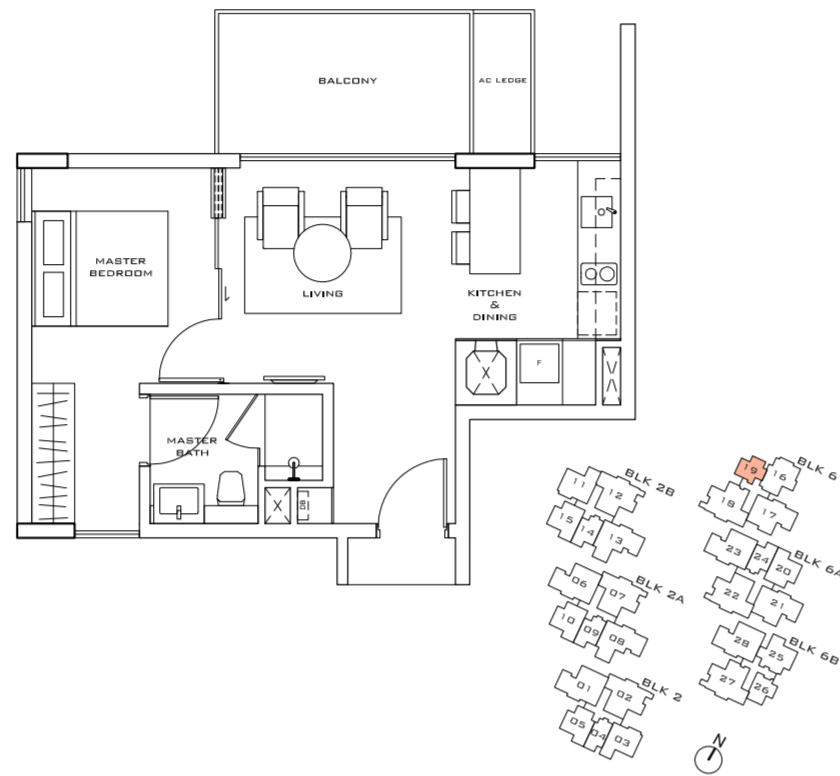

Type B1

83 sq m/893 sq ft
(Including PES 17 sq m/183 sq ft)

2 Bedroom -1G (Ground Level)
#01-05

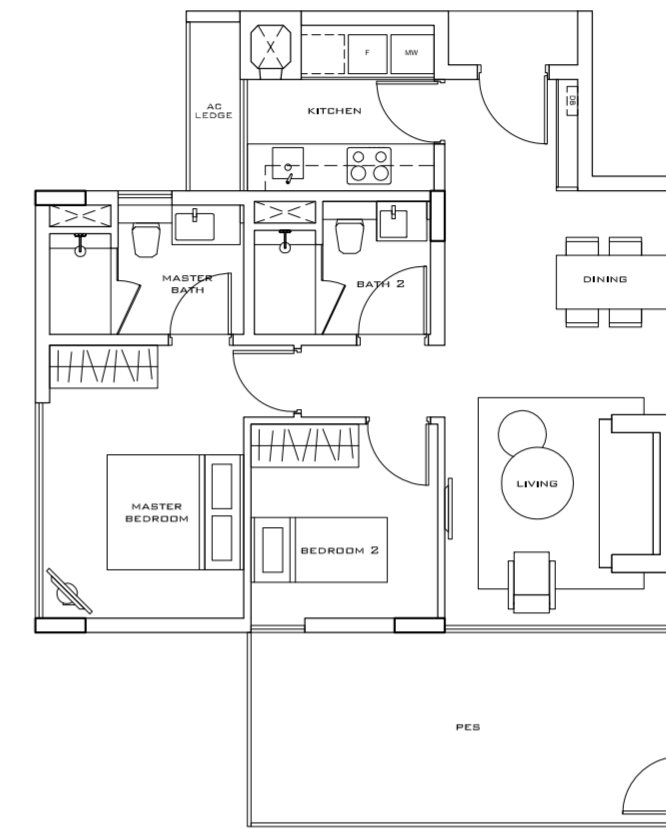

Type C4

49 sq m/527 sq ft
(Including PES 8 sq m/86 sq ft)

1 Bedroom -4G (Ground Level)
#01-26

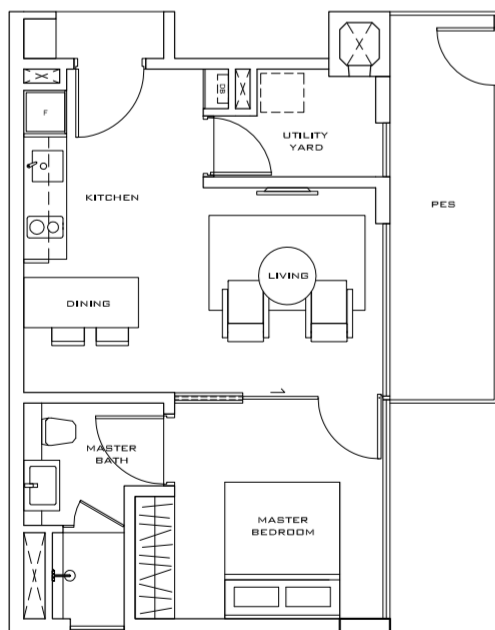

Type C8

49 sq m/527 sq ft

1 Bedroom -4
#02-26, 03-26, 04-26, 05-26

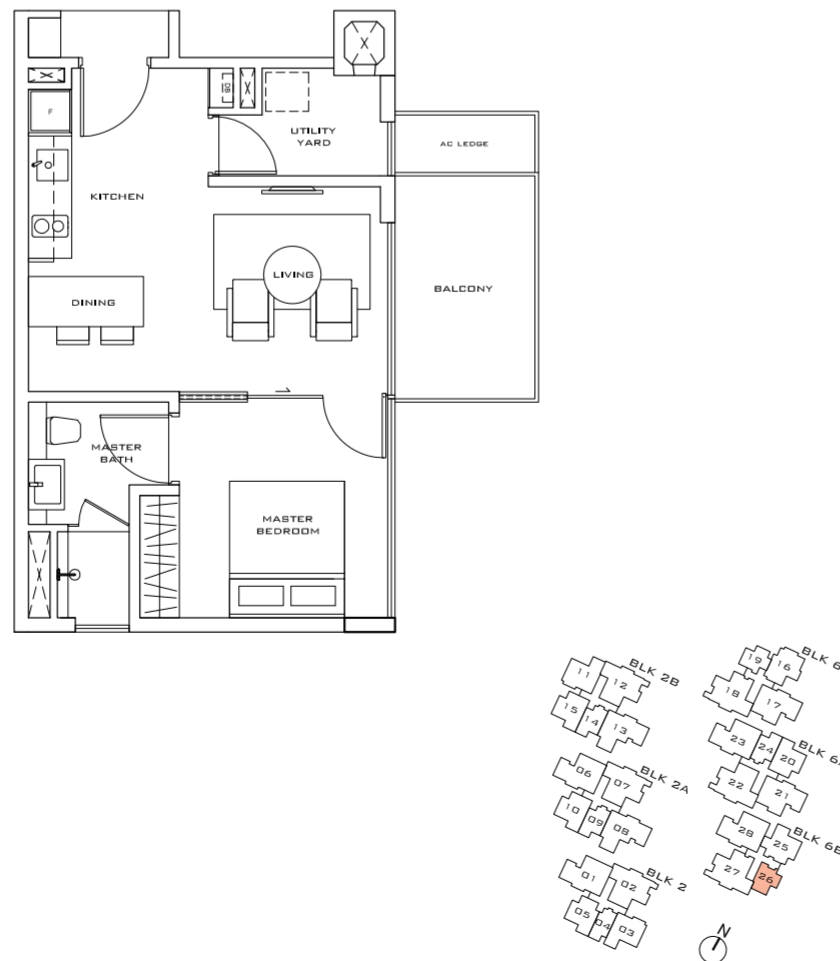

Type B6

74 sq m/797 sq ft

2 Bedroom -1
#02-05, 03-05, 04-05

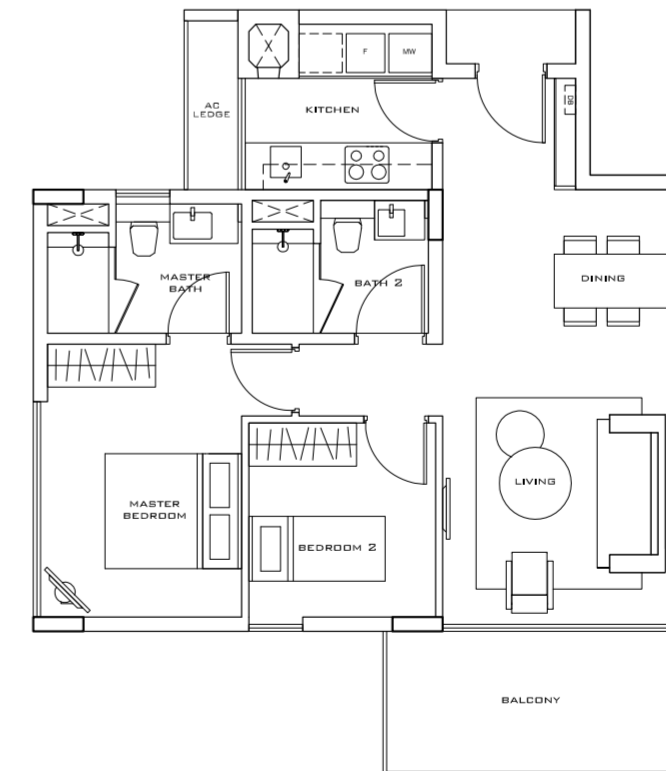

Type B11

150 sq m/1615 sq ft
(Including Roof Terrace 72 sq m/775 sq ft)

2 Bedroom -1PH
(Penthouse, Lower Floor)
#05-05

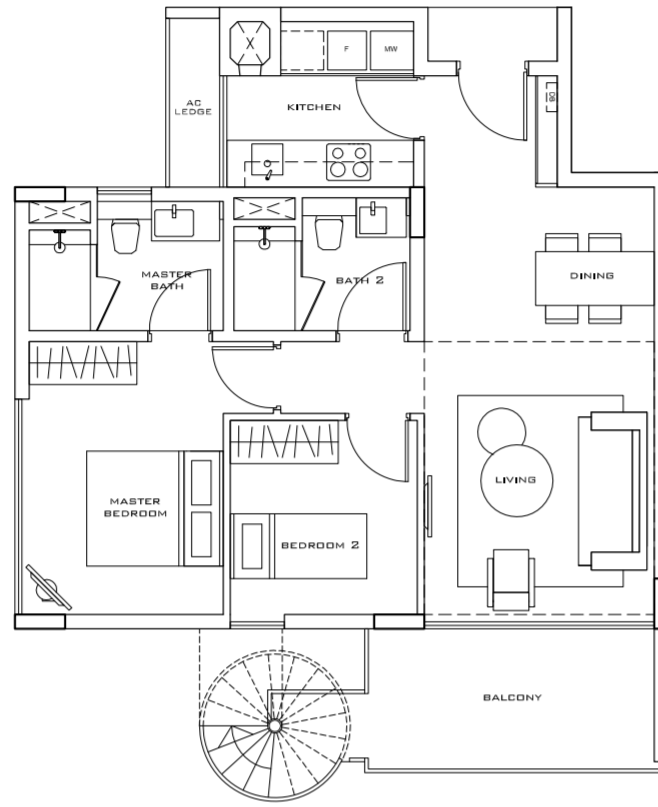

Type B11

2 Bedroom -1 PH
(Penthouse, Upper Floor)

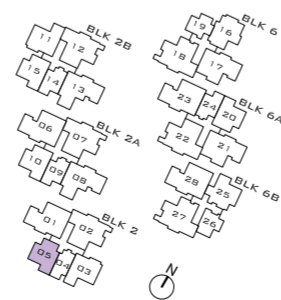
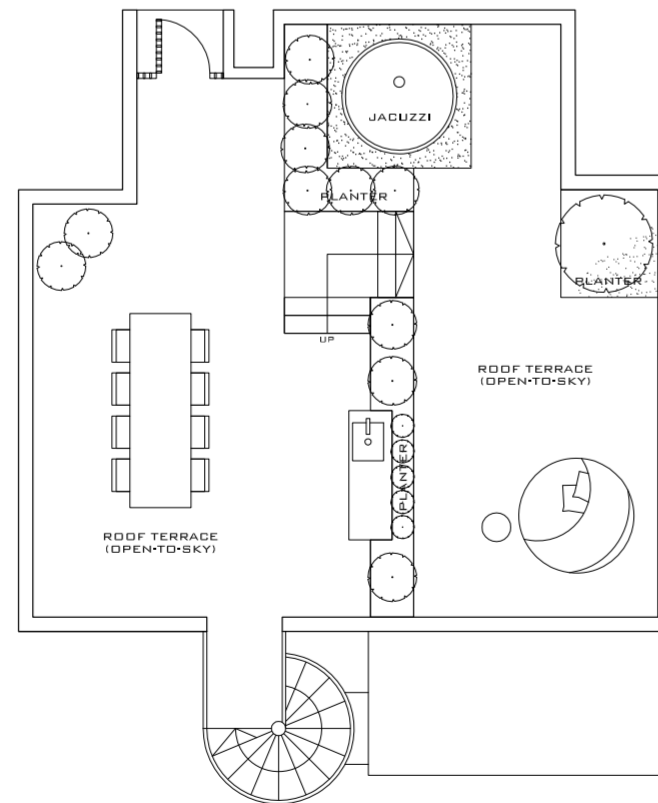

Area includes PES, balcony, AC ledge, planter, private pool and roof terrace. Plans are not drawn to scale and are subject to such amendment(s) as may be required or approved by the relevant authorities. All areas are approximate and are subject to final survey. The brand and model of all fittings, equipment and appliances supplied are subject to availability. In the event that they are not available, the developer will offer replacements of equivalent standard or value.

Type B2

85 sq m/915 sq ft
(Including PES 16 sq m/172 sq ft)

2 Bedroom -1A-G (Ground Level)
#01-10, 01-15, 01-20

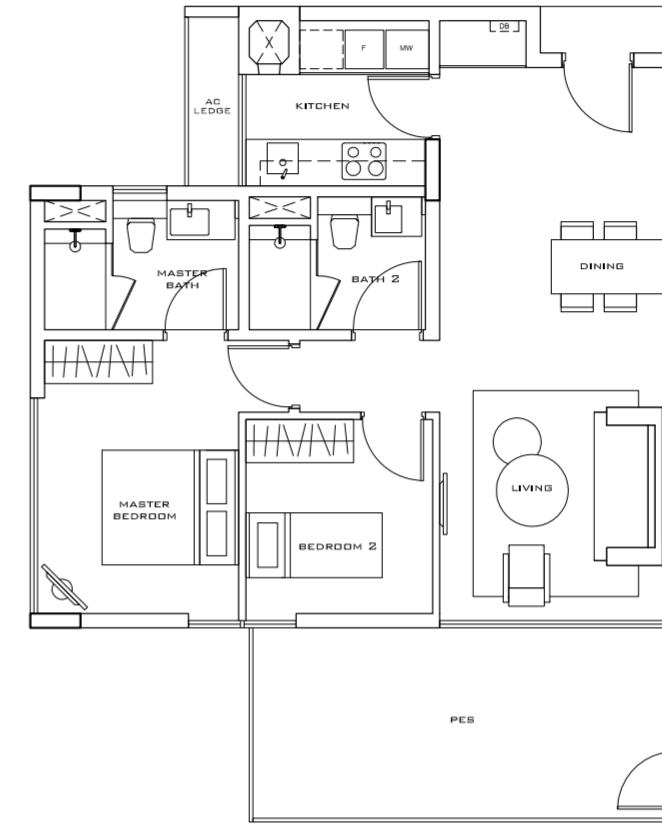

Type B7

78 sq m/840 sq ft

2 Bedroom -1A
#02-10, 03-10, 04-10
#02-15, 03-15, 04-15
#02-20, 03-20, 04-20

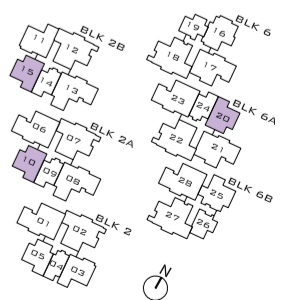
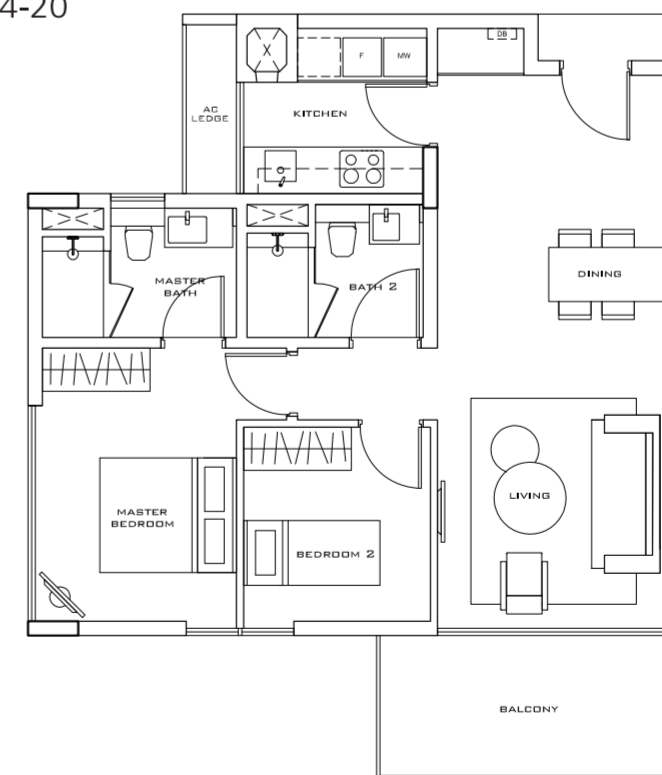

Area includes PES, balcony, AC ledge, planter, private pool and roof terrace. Plans are not drawn to scale and are subject to such amendment(s) as may be required or approved by the relevant authorities. All areas are approximate and are subject to final survey. The brand and model of all fittings, equipment and appliances supplied are subject to availability. In the event that they are not available, the developer will offer replacements of equivalent standard or value.

Type B12

156 sq m/1679 sq ft
(Including Roof Terrace 75 sq m/807 sq ft)

2 Bedroom -1A-PH
(Penthouse, Lower Floor)
#05-10, 05-15, 05-20

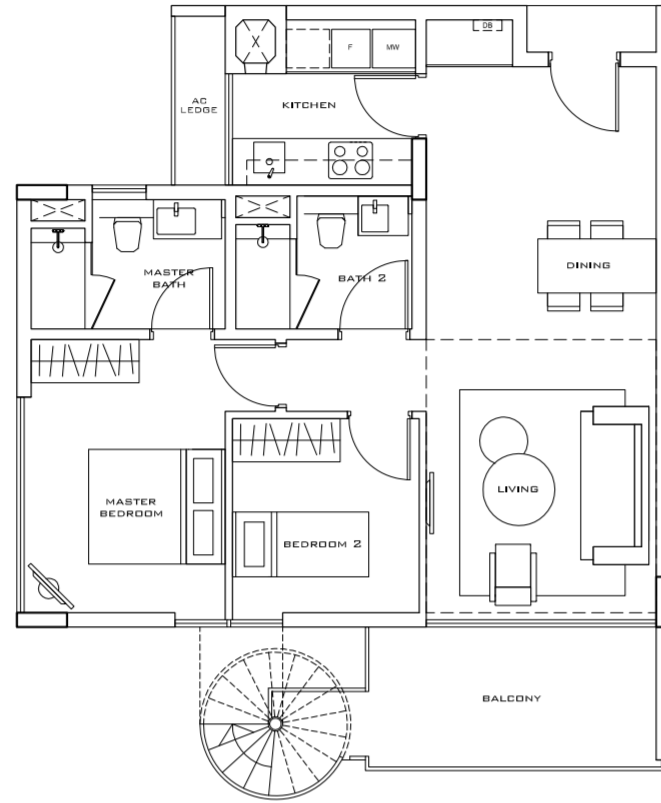

Type B13

168 sq m/1808 sq ft
(Including Roof Terrace 80 sq m/861 sq ft)

2 Bedroom -1B-PH
(Penthouse, Lower Floor)
#05-25

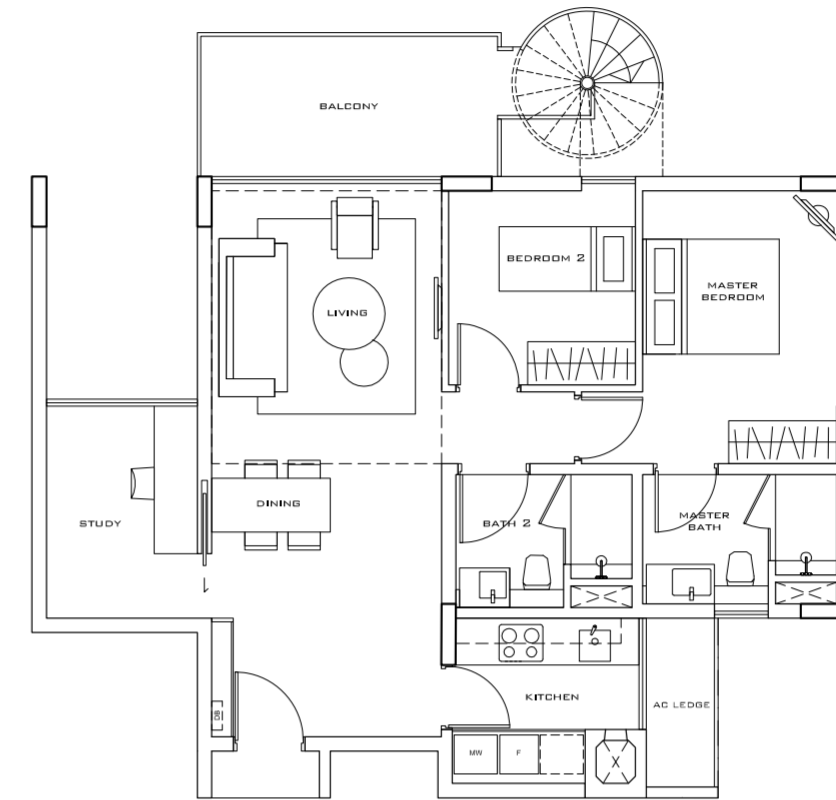

Type B12

2 Bedroom -1A-PH
(Penthouse, Upper Floor)

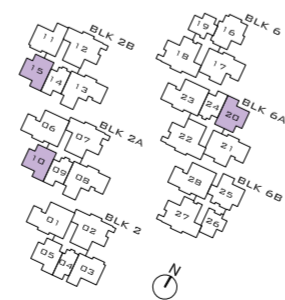
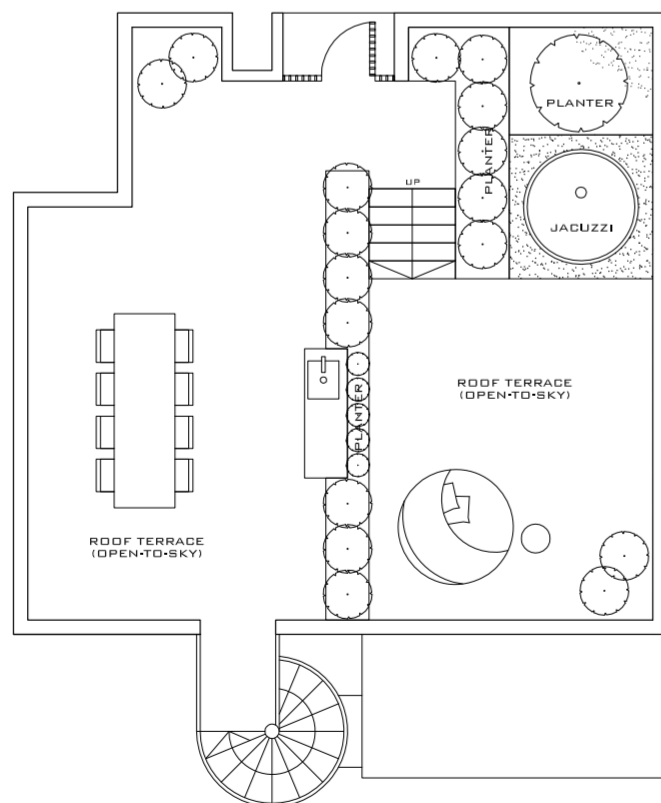

Type B13

2 Bedroom -1B-PH
(Penthouse, Upper Floor)

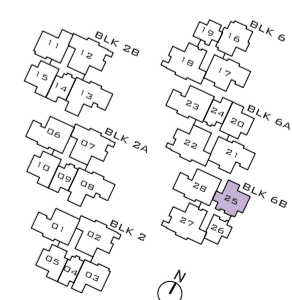
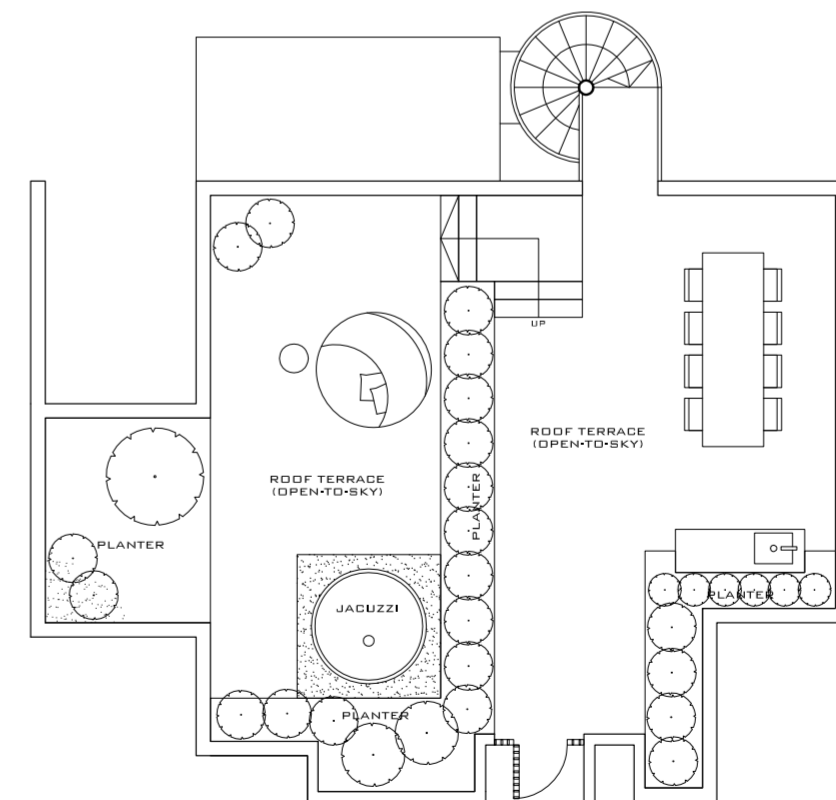

Type B3

95 sq m/1023 sq ft
(Including PES 19 sq m/205 sq ft)

2 Bedroom -1B-G (Ground Level)
#01-25

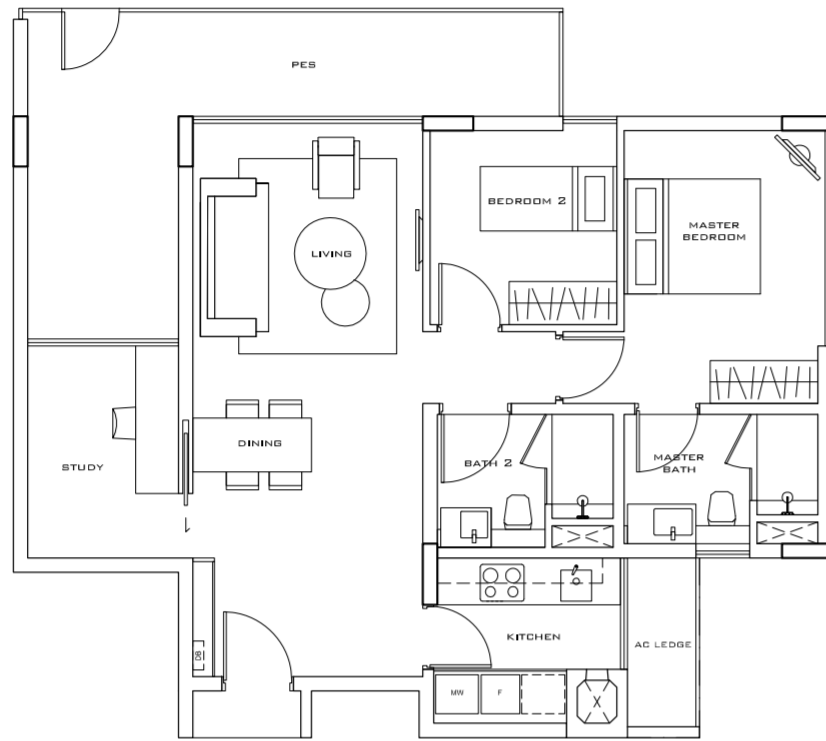

Type B8

84 sq m/904 sq ft

2 Bedroom -1B
#02-25, 03-25, 04-25

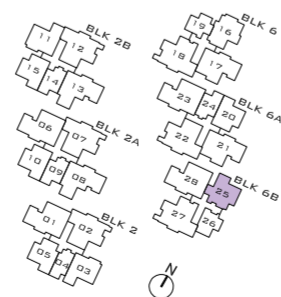

Type B14

164 sq m/1765 sq ft
(Including Roof Terrace 76 sq m/818 sq ft)

2 Bedroom -2-PH
(Penthouse, Lower Floor)
#05-03

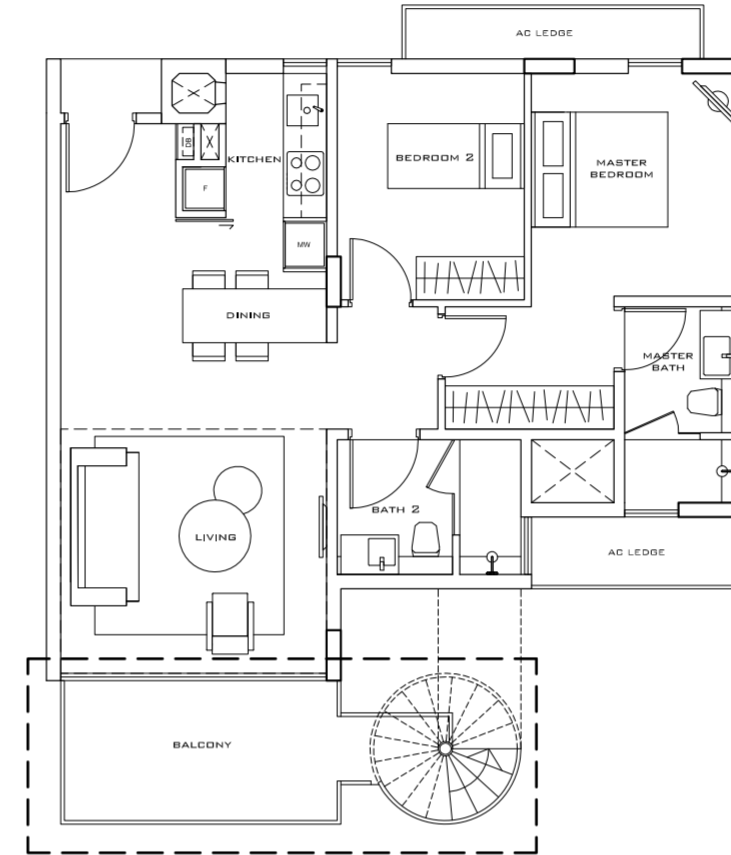

Type B14A

164 sq m/1765 sq ft
(Including Roof Terrace 76 sq m/818 sq ft)

2 Bedroom -2A-PH
(Penthouse, Lower Floor)
#05-11

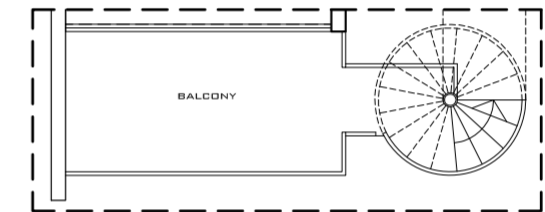

Type B14

2 Bedroom -2-PH
(Penthouse, Upper Floor)
#05-03

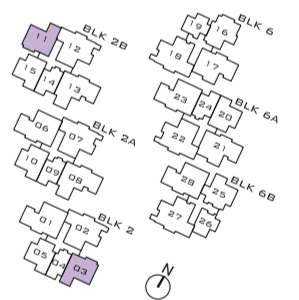
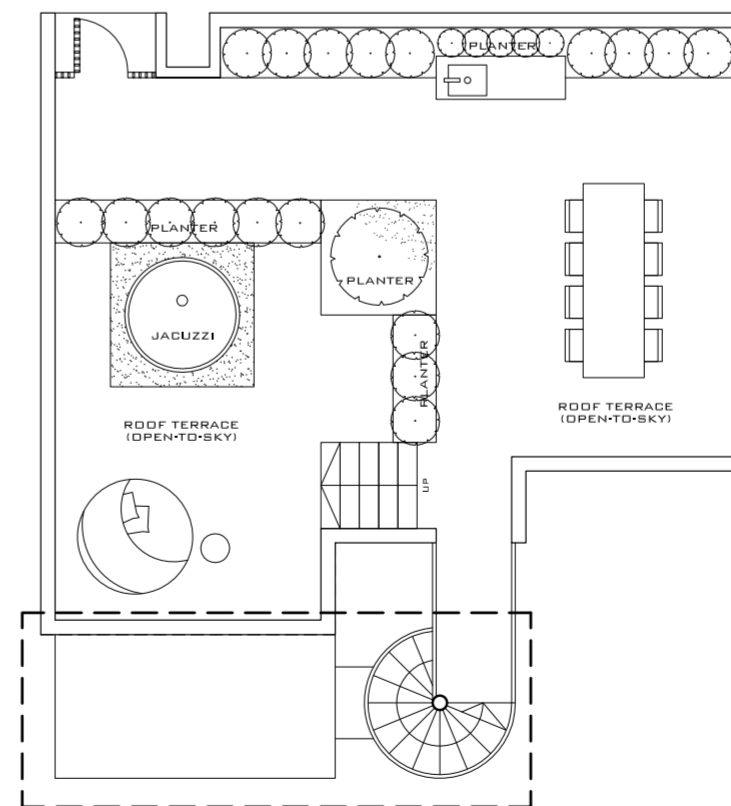

Type B14A

2 Bedroom -2A-PH
(Penthouse, Upper Floor)
#05-11

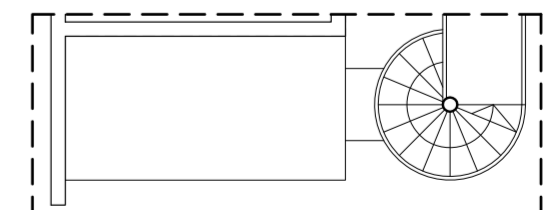

Type B4

87 sq m/936 sq ft
(Including PES 14 sq m/151 sq ft)

2 Bedroom -2-G (Ground Level)
#01-03, #01-11

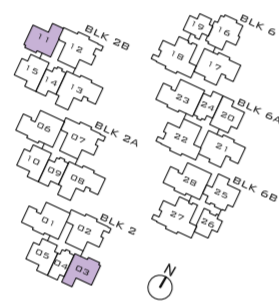
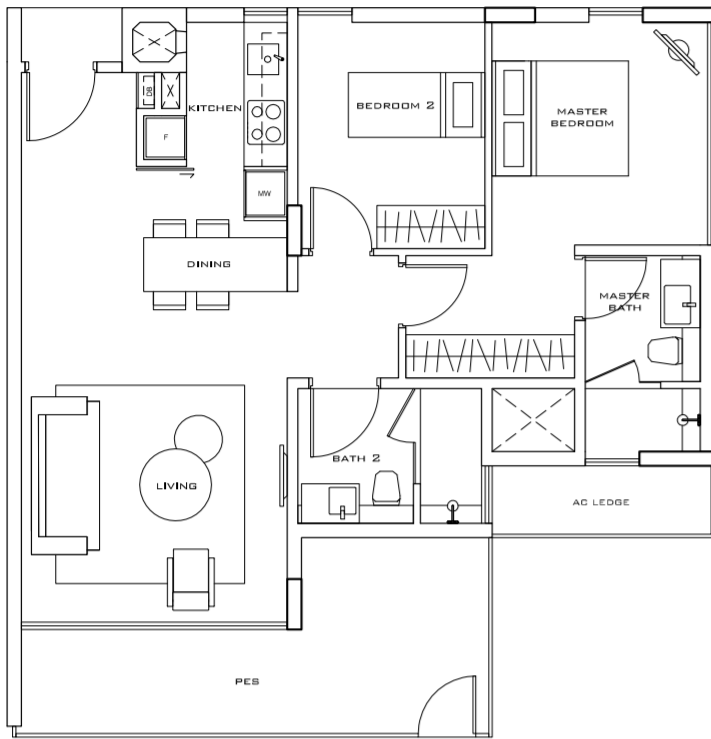

Type B9

85 sq m/915 sq ft

2 Bedroom-2
#02-03, 03-03, 04-03

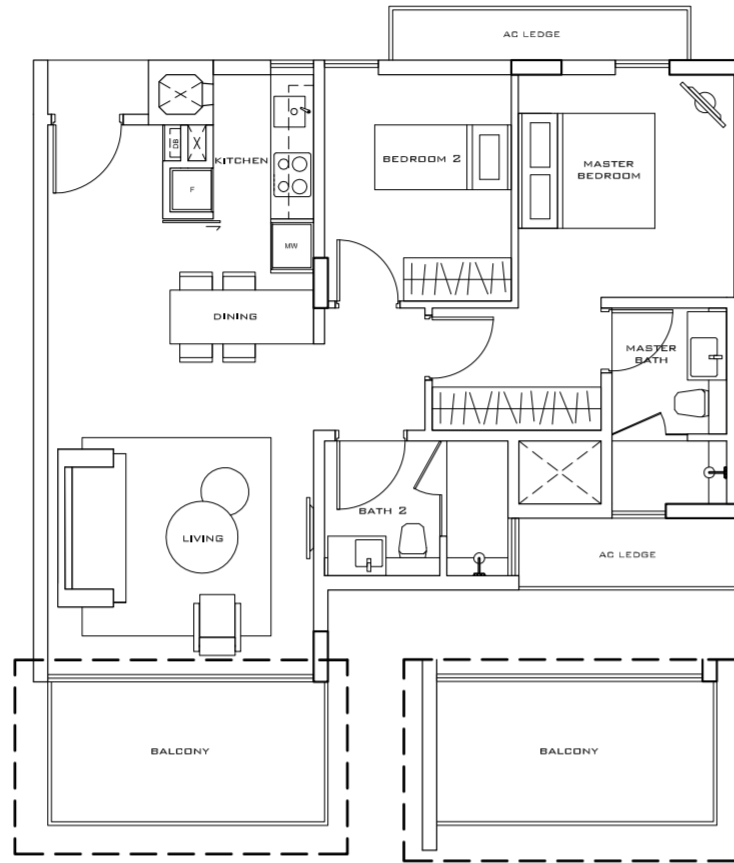

Type B9A

85 sq m/915 sq ft

2 Bedroom-2A
#02-11, 03-11, 04-11

Type B5

87 sq m/936 sq ft
(Including PES 16 sq m/172 sq ft)

2 Bedroom -3-G (Ground Level)
#01-16

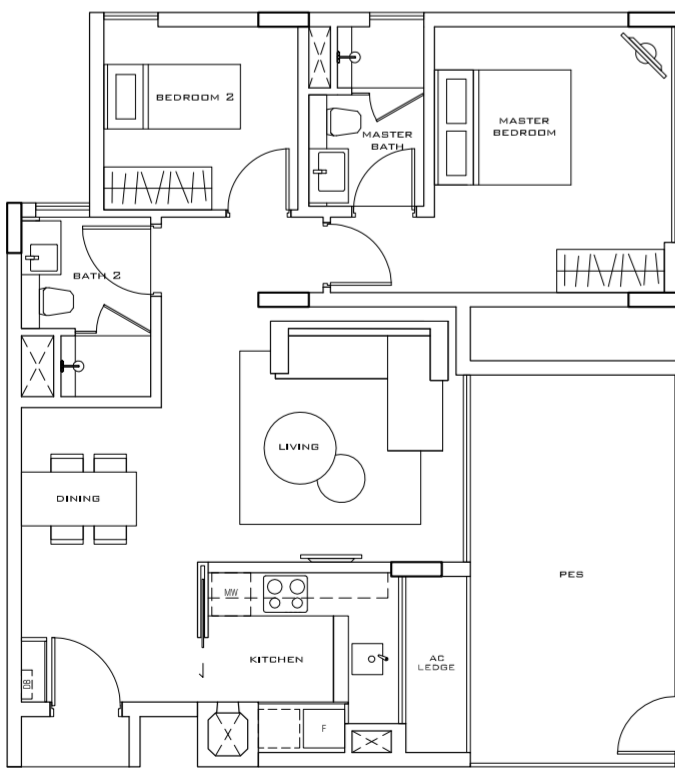

Type B10

86 sq m/926 sq ft

2 Bedroom -3
#02-16, 03-16, 04-16

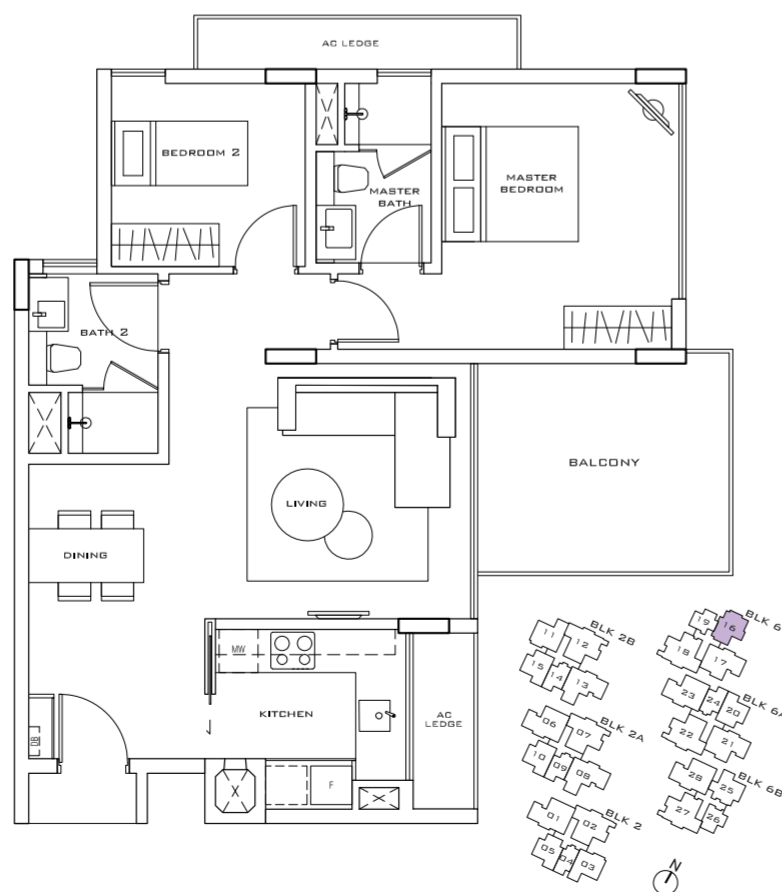

Type B15

165 sq m/1776 sq ft
(Including Roof Terrace 75 sq m/807 sq ft)

2 Bedroom -3-PH
(Penthouse, Lower Floor)
#05-16

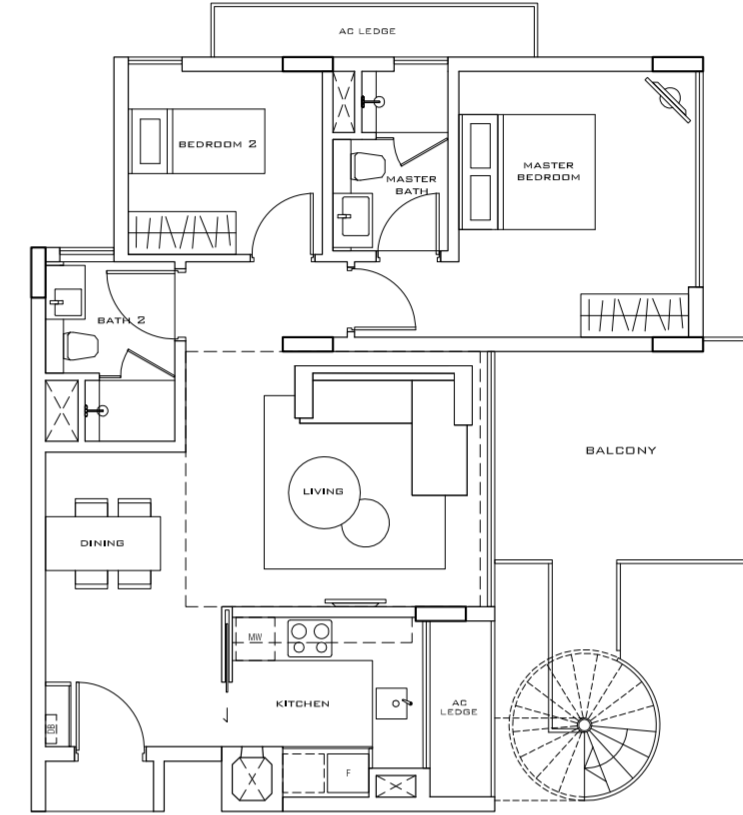

Type B15

2 Bedroom -3-PH
(Penthouse, Upper Floor)

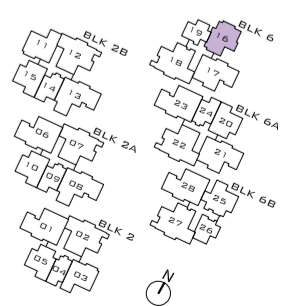
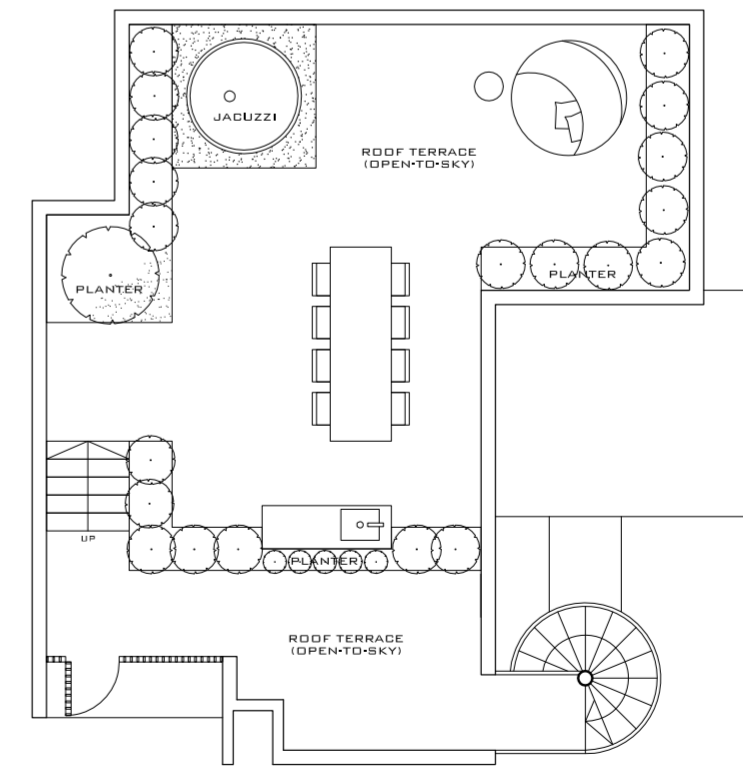

Type A1

105 sq m/1130 sq ft
(Including PES 12 sq m/129 sq ft)

3 Bedroom -1-G (Ground Level)
#01-08, #01-13

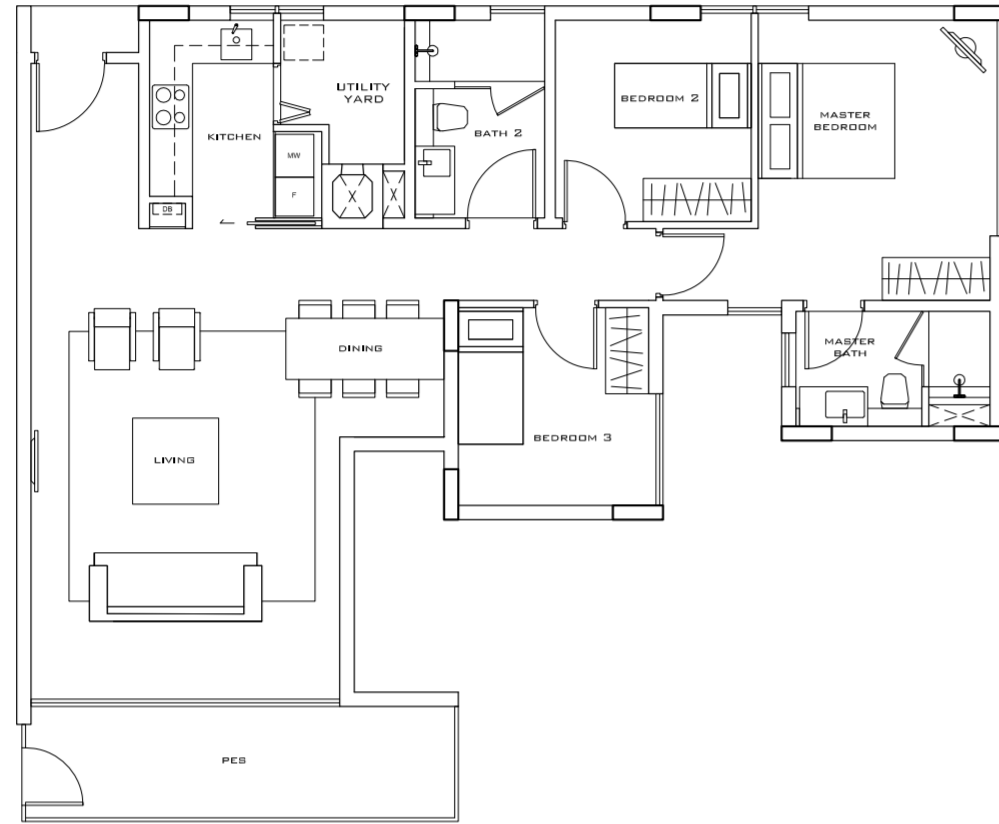

Type A7

206 sq m/2217 sq ft
(Including Roof Terrace 89 sq m/958 sq ft)

3 Bedroom -1-PH
(Penthouse, Lower Floor)
#05-08, #05-13

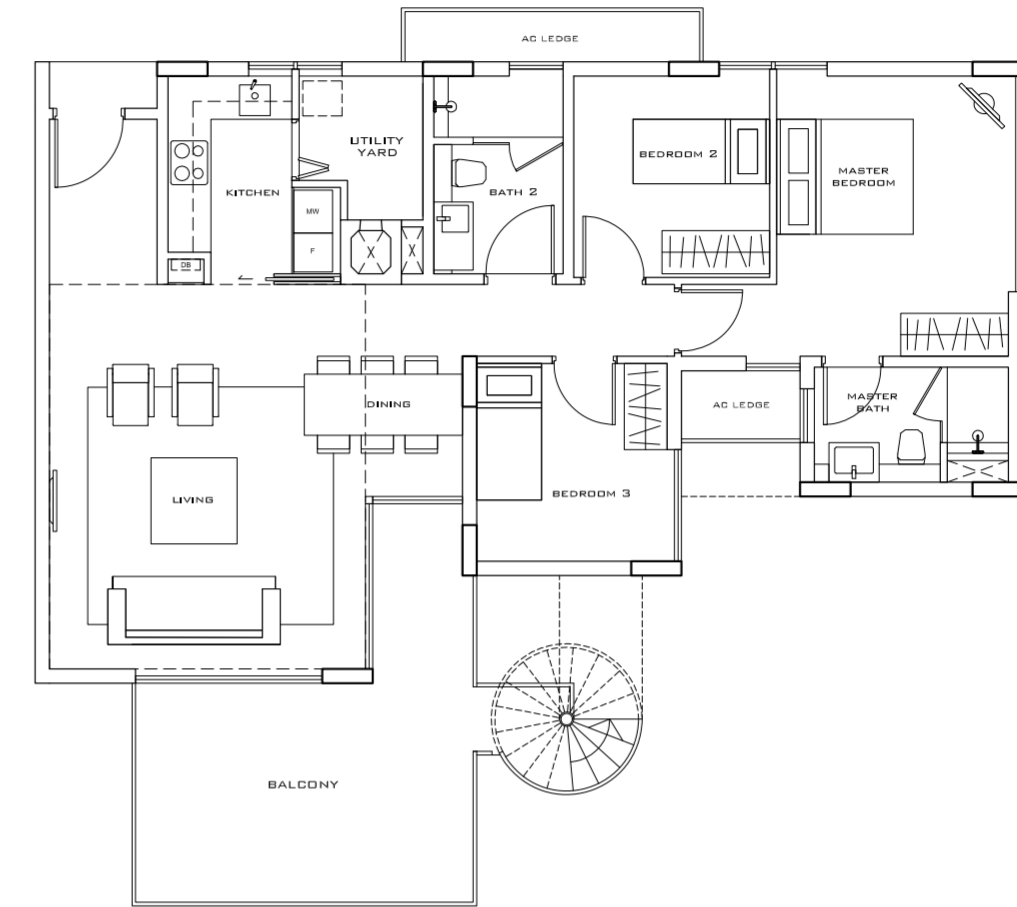

Type A4

114 sq m/1227 sq ft

3 Bedroom -1
#02-08, 03-08, 04-08
#02-13, 03-13, 04-13

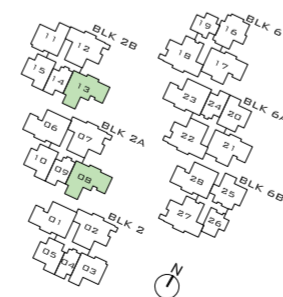
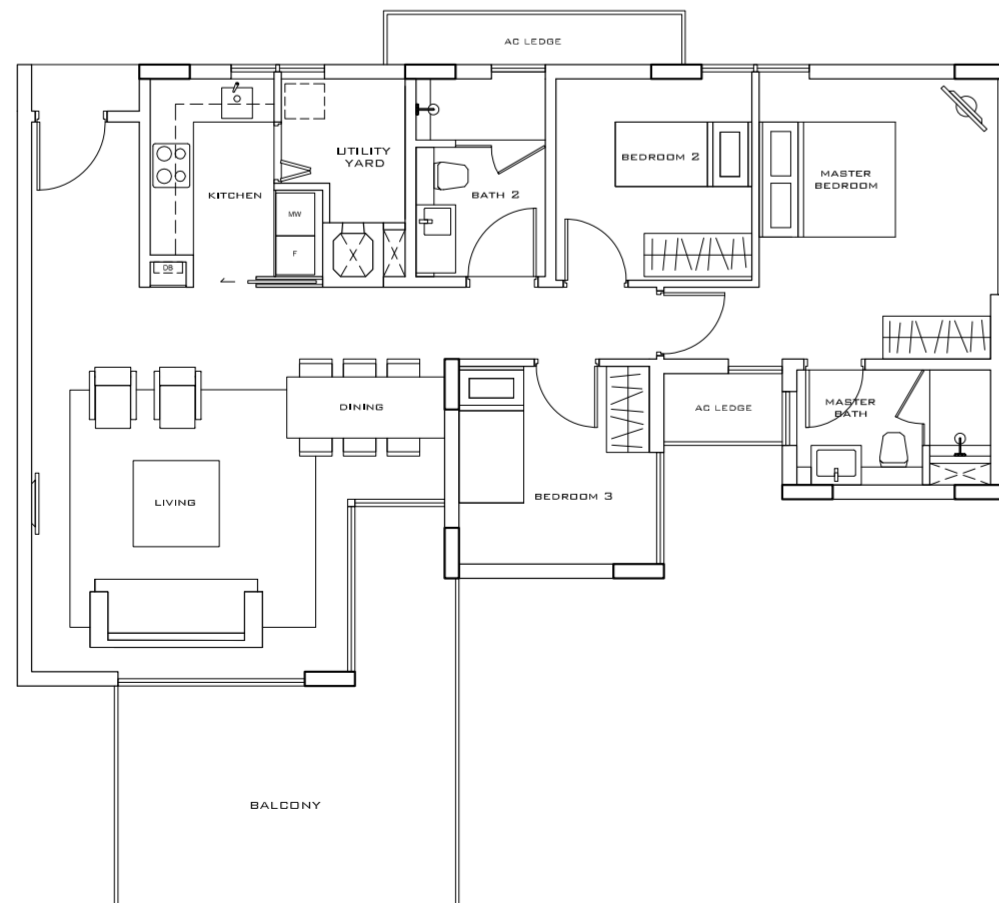

Type A7

3 Bedroom -1-PH
(Penthouse, Upper Floor)

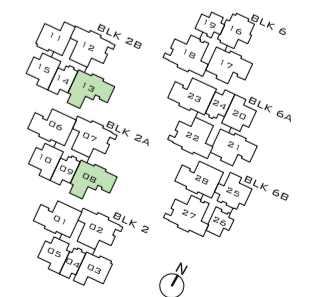
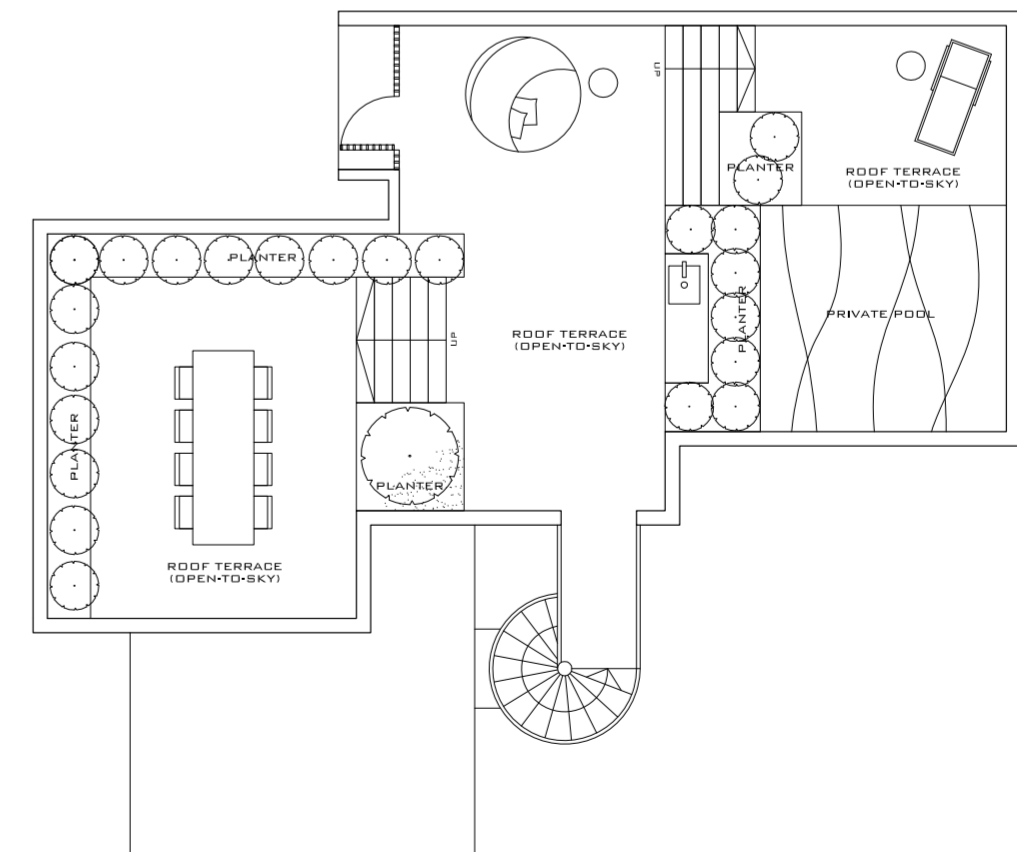

Area includes PES, balcony, AC ledge, planter, private pool and roof terrace. Plans are not drawn to scale and are subject to such amendment(s) as may be required or approved by the relevant authorities. All areas are approximate and are subject to final survey. The brand and model of all fittings, equipment and appliances supplied are subject to availability. In the event that they are not available, the developer will offer replacements of equivalent standard or value.

Area includes PES, balcony, AC ledge, planter, private pool and roof terrace. Plans are not drawn to scale and are subject to such amendment(s) as may be required or approved by the relevant authorities. All areas are approximate and are subject to final survey. The brand and model of all fittings, equipment and appliances supplied are subject to availability. In the event that they are not available, the developer will offer replacements of equivalent standard or value.

Type A2

122 sq m/1313 sq ft
(Including PES 28 sq m/301 sq ft)

3 Bedroom - 1A-G
(Ground Level)
#01-01, #01-06, #01-17
#01-21, #01-23, #01-28

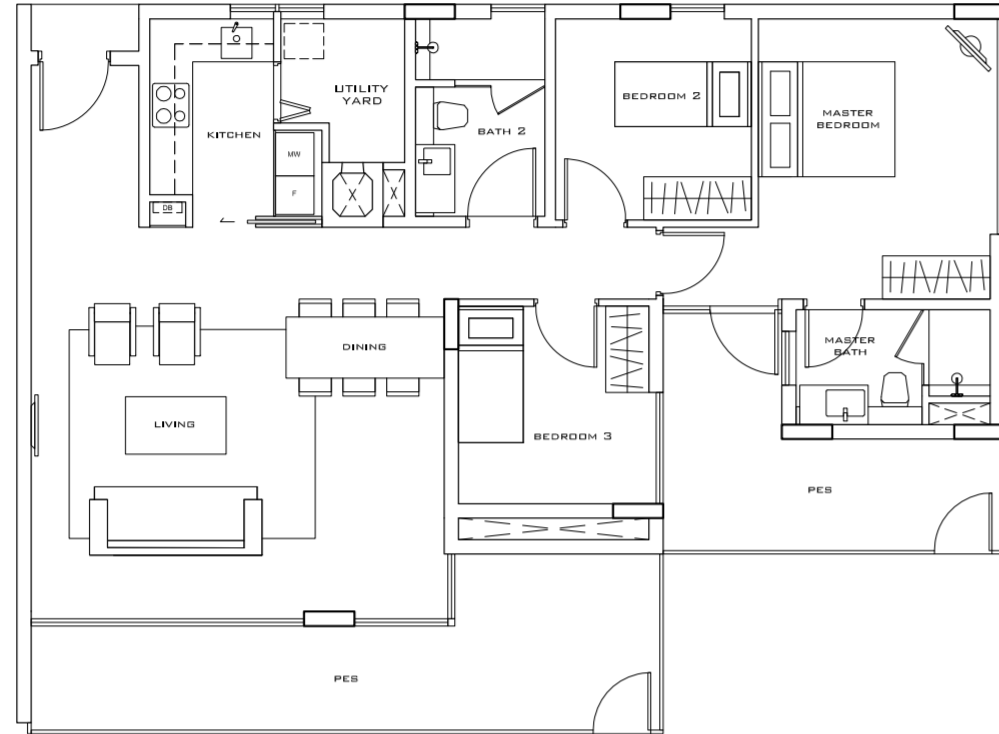

Type A8

202 sq m/2174 sq ft
(Including Roof Terrace 90 sq m/969 sq ft)

3 Bedroom -1A-PH
(Penthouse, Lower Floor)
#05-01, 05-06, 05-17, 05-21, 05-23, 05-28

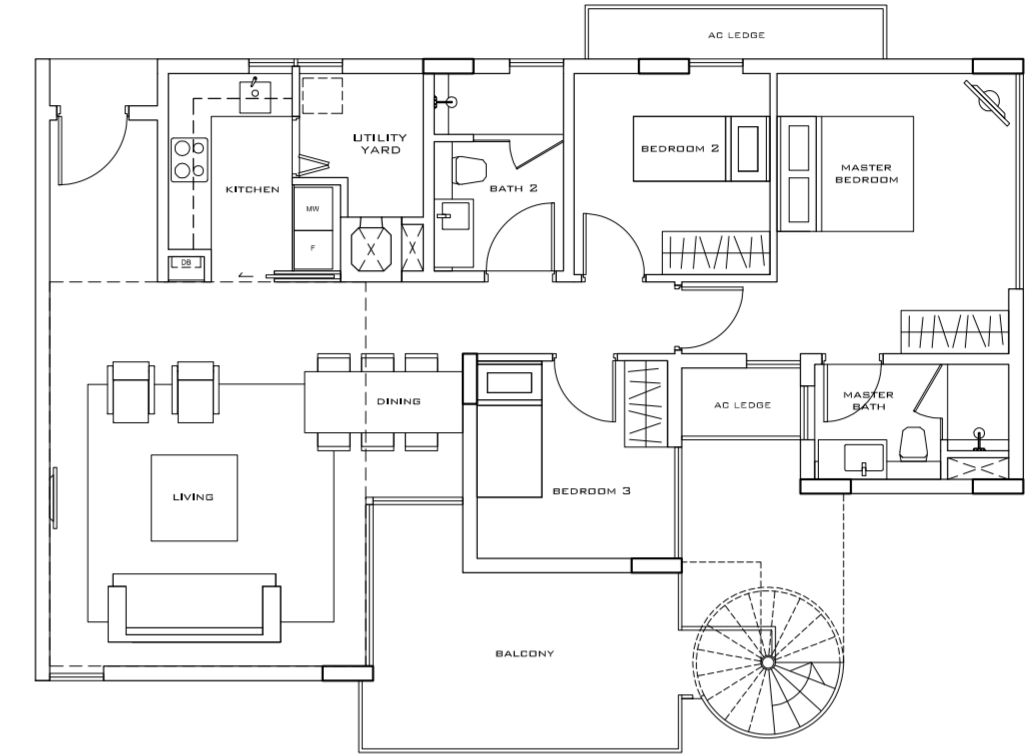

Type A5

108 sq m/1163 sq ft

3 Bedroom-1A
#02-01, 03-01, 04-01
#02-06, 03-06, 04-06
#02-17, 03-17, 04-17
#02-21, 03-21, 04-21
#02-23, 03-23, 04-23
#02-28, 03-28, 04-28

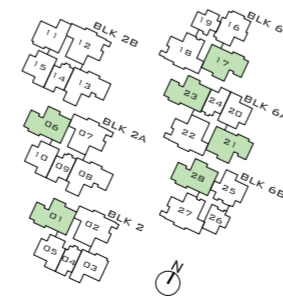
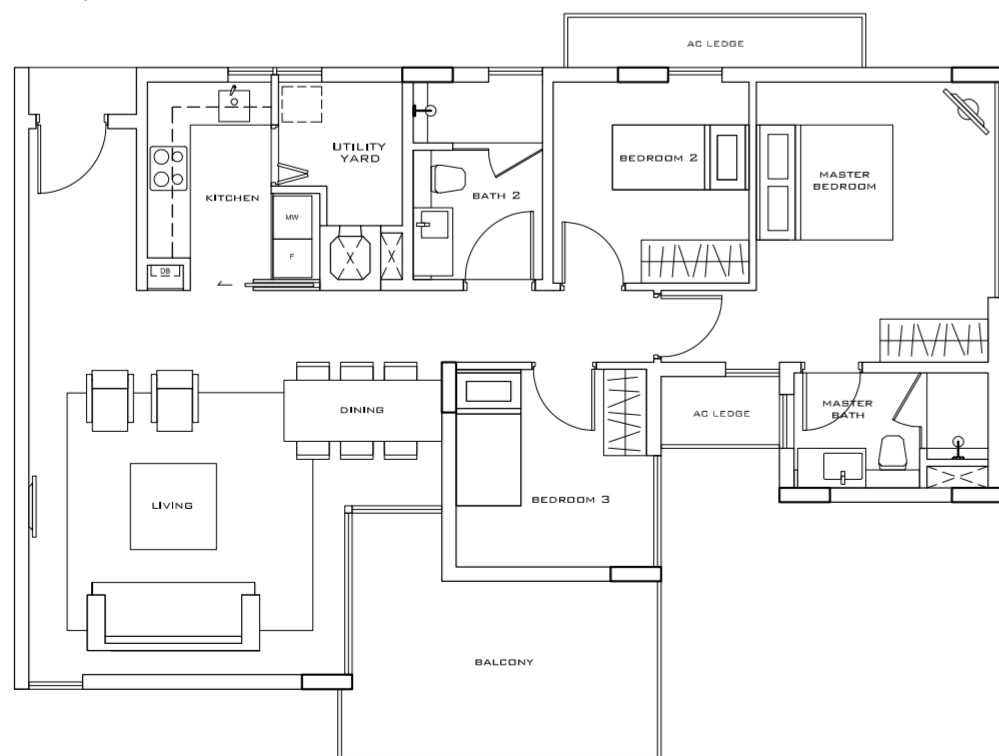

Type A8

3 Bedroom -1A-PH
(Penthouse, Upper Floor)

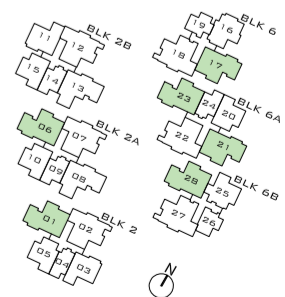
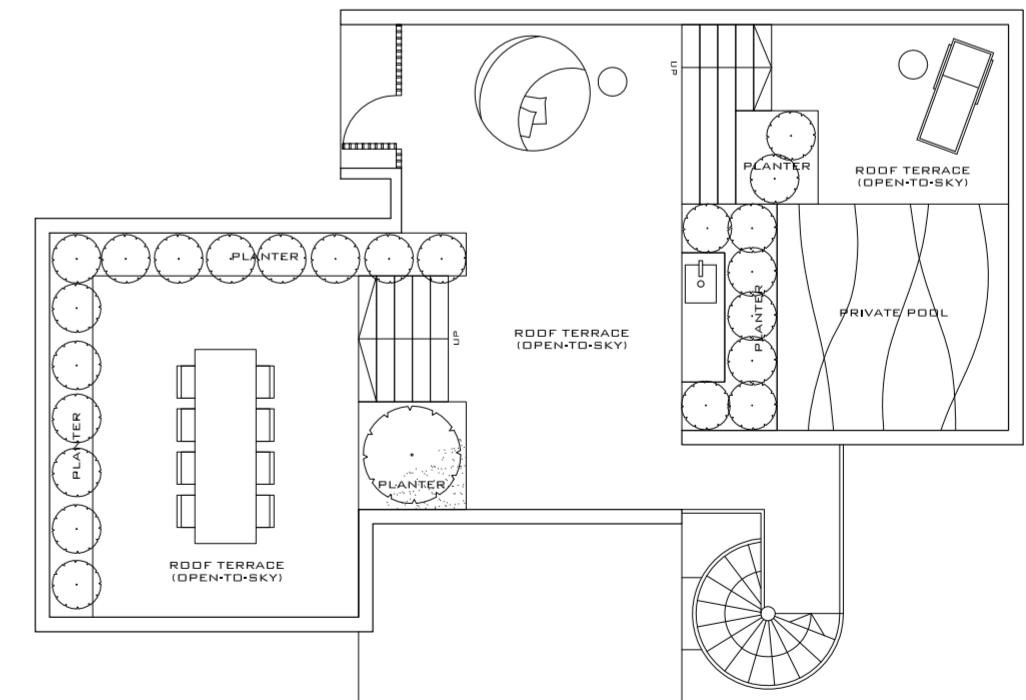

Area includes PES, balcony, AC ledge, planter, private pool and roof terrace. Plans are not drawn to scale and are subject to such amendment(s) as may be required or approved by the relevant authorities. All areas are approximate and are subject to final survey. The brand and model of all fittings, equipment and appliances supplied are subject to availability. In the event that they are not available, the developer will offer replacements of equivalent standard or value.

Area includes PES, balcony, AC ledge, planter, private pool and roof terrace. Plans are not drawn to scale and are subject to such amendment(s) as may be required or approved by the relevant authorities. All areas are approximate and are subject to final survey. The brand and model of all fittings, equipment and appliances supplied are subject to availability. In the event that they are not available, the developer will offer replacements of equivalent standard or value.

Type A3

114 sq m/1227 sq ft
(Including PES 20 sq m/215 sq ft)

3 Bedroom - 2-G
(Ground Level)
#01-02, 01-07, 01-12
#01-18, 01-22, 01-27

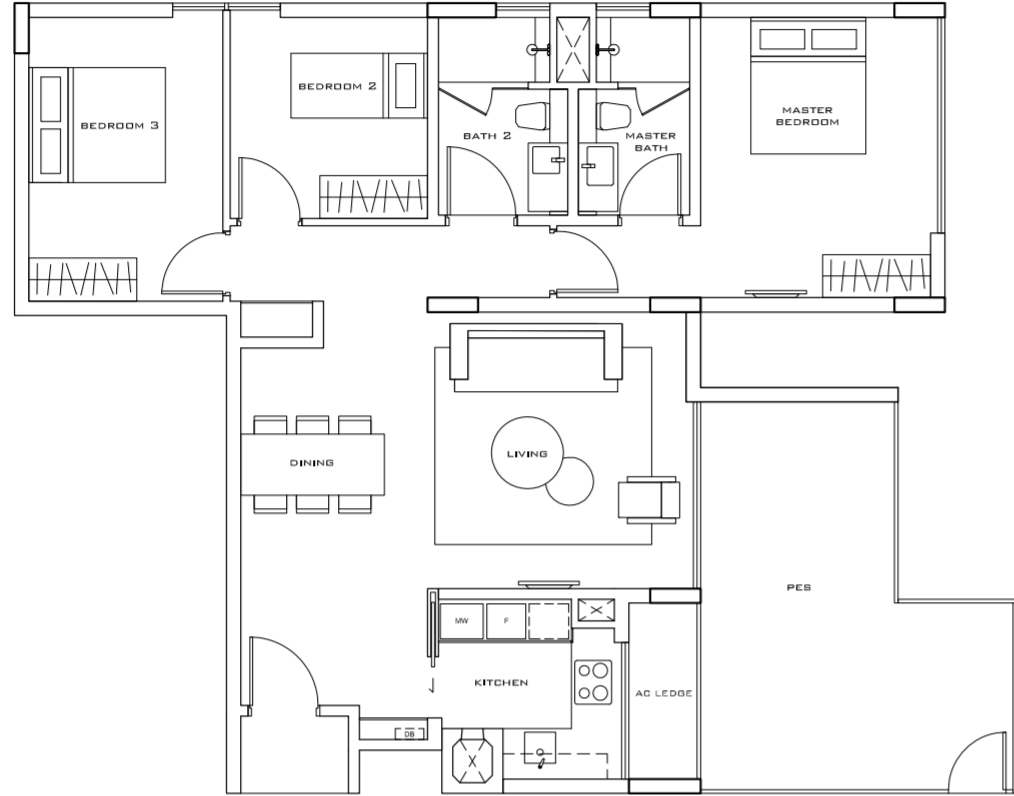

Type A6

116 sq m/1249 sq ft

3 Bedroom - 2
#02-02, 03-02, 04-02
#02-07, 03-07, 04-07
#02-12, 03-12, 04-12
#02-18, 03-18, 04-18
#02-22, 03-22, 04-22
#02-27, 03-27, 04-27

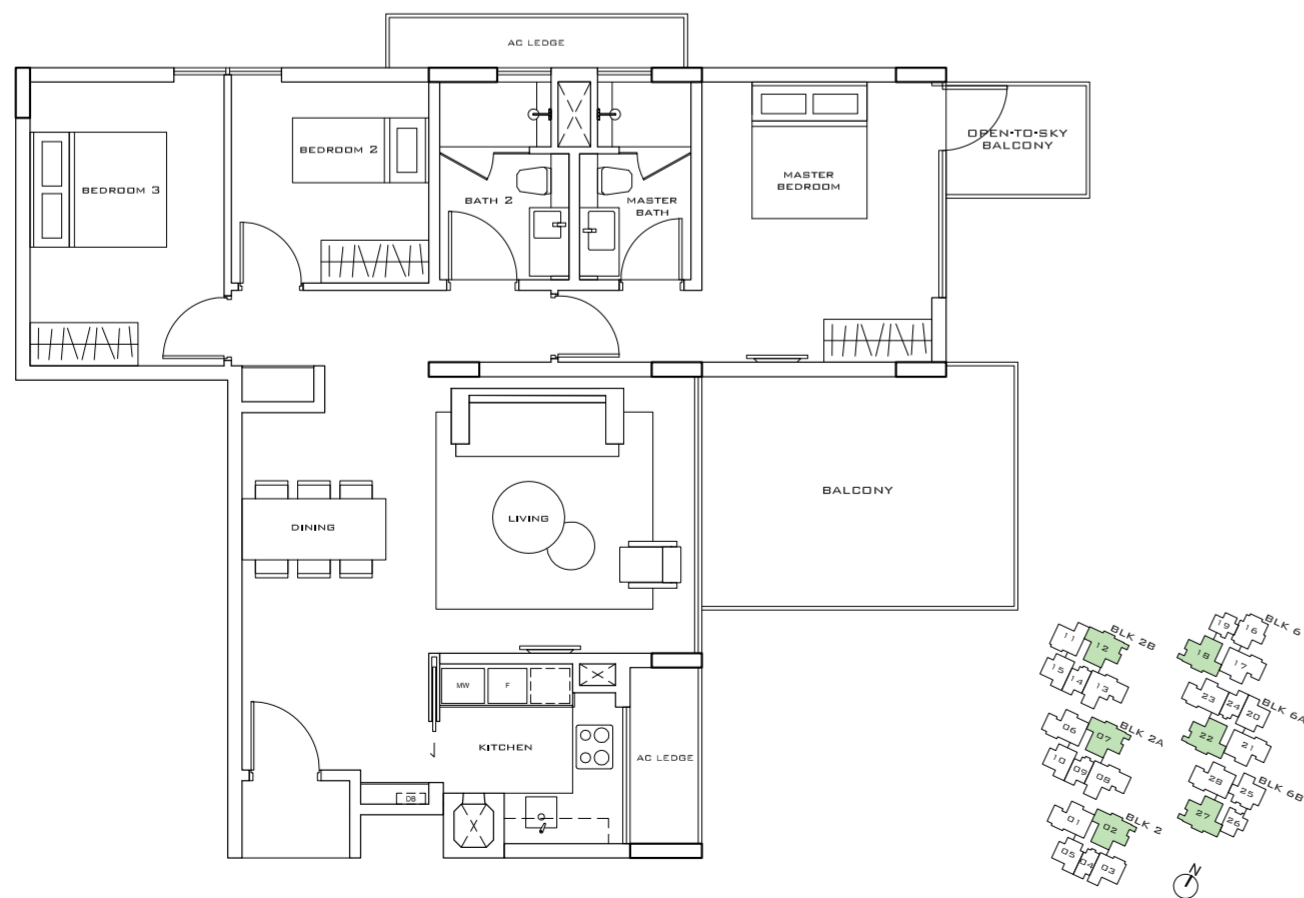

Type A9

219 sq m/2357 sq ft
(Including Roof Terrace 99 sq m/1066 sq ft)

3 Bedroom - 2-PH
(Penthouse, Lower Floor)
#05-02, 05-07, 05-12, 05-18, 05-22, 05-27

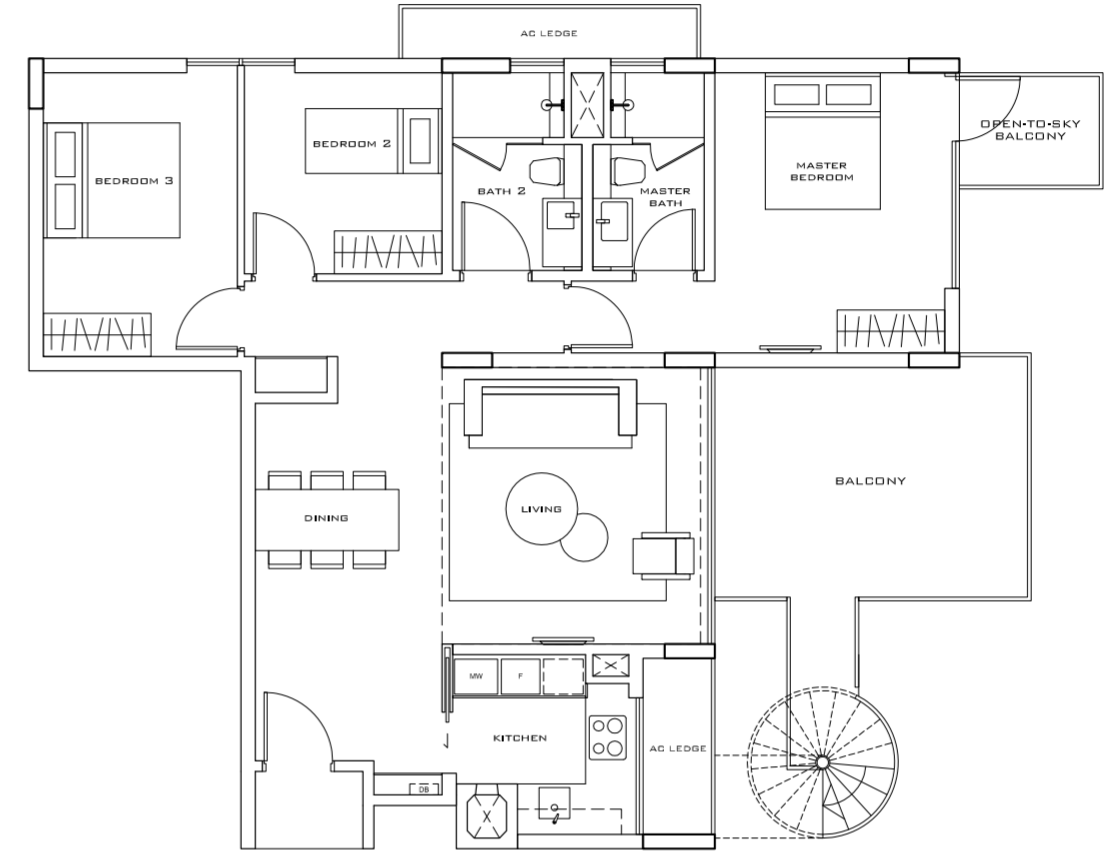

Type A9

3 Bedroom - 2-PH
(Penthouse, Upper Floor)

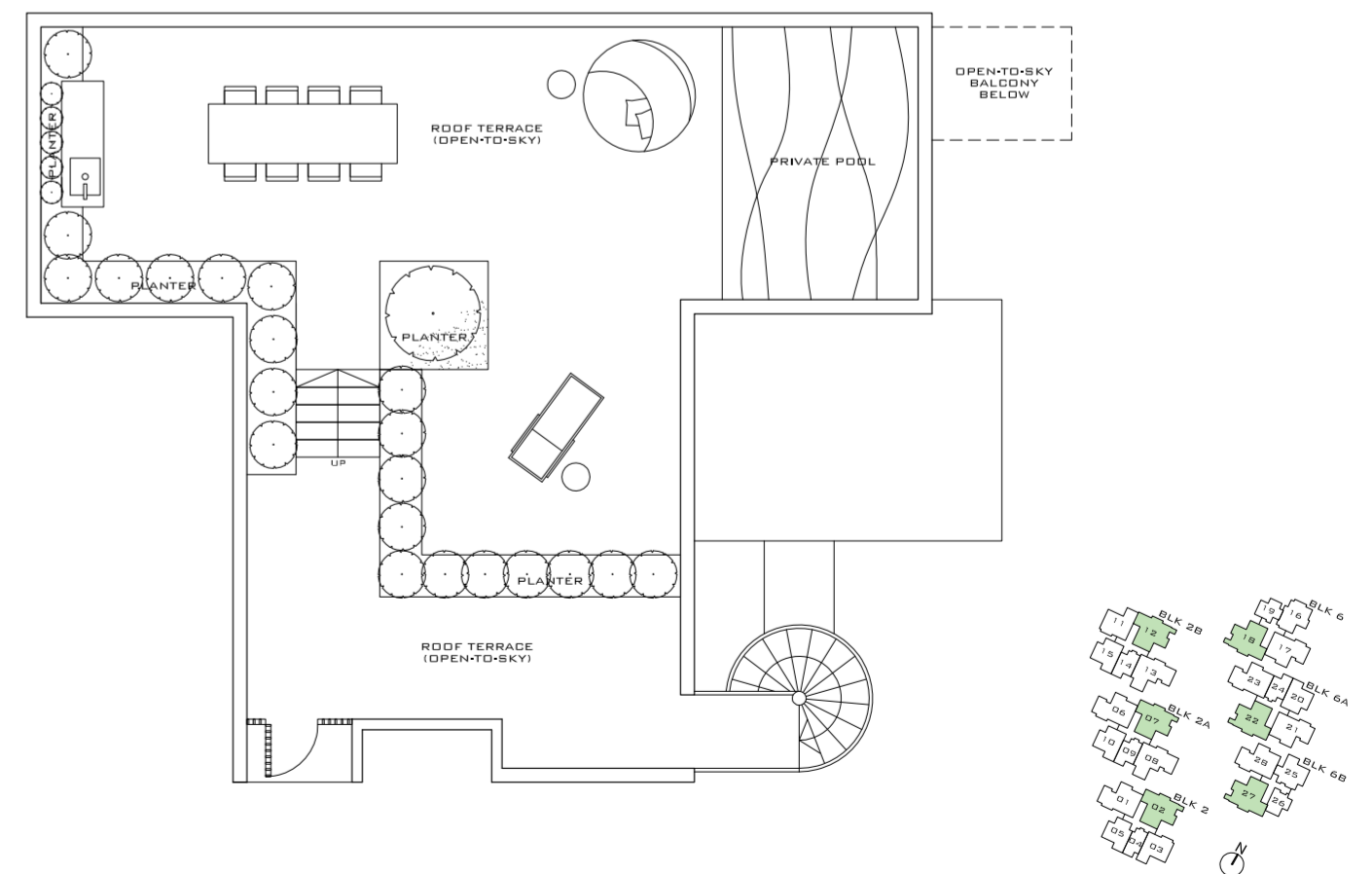

Area includes PES, balcony, AC ledge, planter, private pool and roof terrace. Plans are not drawn to scale and are subject to such amendment(s) as may be required or approved by the relevant authorities. All areas are approximate and are subject to final survey. The brand and model of all fittings, equipment and appliances supplied are subject to availability. In the event that they are not available, the developer will offer replacements of equivalent standard or value.

Area includes PES, balcony, AC ledge, planter, private pool and roof terrace. Plans are not drawn to scale and are subject to such amendment(s) as may be required or approved by the relevant authorities. All areas are approximate and are subject to final survey. The brand and model of all fittings, equipment and appliances supplied are subject to availability. In the event that they are not available, the developer will offer replacements of equivalent standard or value.

Developer's Profile

Bliss@Kovan rises in the Singapore skyline, along with 8 Nassim Hill and Lush on Holland Hill, as the newest installation in BBR Holdings (S) Ltd's portfolio of prestigious residential developments.

Built firmly on a 67-year foundation by three Swiss engineers, Brandestini, Birkenmaier, and Ros – The BBR Network is today comprised of a global network of affiliated companies, joint ventures and franchises offering specialist construction engineering across 46 countries. Bliss@Kovan is created on this solid reputation.

Incorporated in 1993 in partnership with the Switzerland-based BBR Network, BBR Holdings was listed on the Singapore Stock Exchange in 1997 and has since then been transferred to the Main Board of the Singapore Exchange Securities Trading Limited in September 2006. The Group has established strong market presence in Singapore, Malaysia, Thailand, Philippines and Korea – with 3-core principal services in General Construction, Specialised Engineering and Property Development. All of which come together to lend a synergised alliance and expertise in the projects undertaken.

With Bliss@Kovan, BBR Holdings holds true to its intention to be positioned as a boutique developer focusing on creating residential properties in prime locations around Singapore.

Developer:



About the architect

LOOK Architects is a multi-award winning practice committed to rigorous analysis and research to produce innovative, iconic buildings and urban design. Embracing local sensibilities with a global outlook, LOOK Architects has garnered international acclaim for consistent achievements in design excellence – principal architect Look Boon Gee is the recipient of the prestigious President's Design Award Singapore 2009 – Designer of the Year, while the firm has received recognition from The Chicago Athenaeum for its efforts in both civic building and urban landscape design. Establishing a prolific and wide-ranging portfolio including high-rise condominiums, mixed-use developments, varsity institution, waterfront promenade, bridges and a public library, LOOK Architects strives to bring about innovation on projects of various scales and programmatic demands.



Now, live your truest element.

Here you are in your element, everything feels just right, naturally in Bliss@Kovan.



BCA GREEN MARK

This development has been awarded the BCA GREEN MARK GOLD PLUS for its Environmentally Sustainable Design.

- Developer: BBR Kovan Pte. Ltd. (Co Reg No 200916020M) • Licence No: C0788 • Tenure: Estate in Fee Simple (Freehold) • Expected date of vacant possession: 31 December 2015
- Expected date of legal completion: 31 December 2018 • Location: Lots 3104V & 9507P (formerly known as 7290K pt) of Mukim 22 at Simon Lane • Building Plan No: A1224-00002-2010-BP01 dated 17 June 2011

While every reasonable care has been taken in preparing this brochure and in constructing the models, showflats, layout and/or displays, the developers, their marketing agent(s) and all their respective employees cannot be held responsible for any inaccuracies or omissions.

All information and statements are believed to be correct but are not to be regarded as statements or representations of fact.

Visual representations, illustrations, pictures, photographs, drawings, art renderings and other graphic representations and references are intended to portray only impressions of the housing project, building(s) and/or any unit and cannot form part of any offer or contract or constitute any warranty on our part.

All plans and/or specifications are current at the time of publication and are subject to change or amendments as may be required by us and/or directed and/or approved by the building authorities. Floor areas and any other measurements stated in this brochure are approximate measurements and subject to final survey.

All models, showflats, layout and/or displays are mock ups and are not constructed to scale. They are intended to portray only impressions of the actual units and/or layout and cannot be regarded as representations of the actual layout, size and area of the unit types offered in the housing project. All furniture, fittings and finishings shown in the models, showflats, layout and/or displays are not to be regarded as representations of the furniture, fittings and finishings to be provided and/or representations that such or any furniture, fittings and finishings can be placed in the locations shown in the models, showflats, layout and/or displays.

Purchasers are advised to refer to the approved building plans which are available at the sales office or showflat upon request for all details, plans, measurements and specifications of the housing project and/or the units.

Developer:



BBR Kovan Pte Ltd

A member of the  BBR Group

BBR Building
50 Changi South Street 1 Singapore 486126
Tel: 6546 2280 Fax: 6546 2268
www.bbr.com.sg